





FARE CASA

LA CASA PIÙ BELLA, È QUELLA CON CUI CI SENTIAMO IN SINTONIA NON SOLO NEGLI SPAZI PIU' CANONICI (SOGGIORNO, CUCINA, BAGNO, PATIO...) MA ANCHE IN QUELLI PIU' UMILI E SERVIZIEVOLI, NEI QUALI POSSIAMO AVERE CURA DELLE NOSTRE COSE, OTTIMIZZANDO IL NOSTRO TEMPO. LAVARE E STIRARE IN UN AMBIENTE FUNZIONALE O PIACEVOLE, RIPORRE IN BELL'ORDINE ABITI, SCARPE E OGGETTI, SFRUTTARE AL MEGLIO OGNI SPAZIO. TUTTO QUESTO ANCHE IN UN AMBIENTE ADIBITO A PIU' FUNZIONI CONTEMPORANEAMENTE, CON ARREDI VERSATILI, CAPACI DI DONARCI OGNI GIORNO COMFORT, QUALITA' ED ANCHE EMOZIONI: GRAZIE A BIREX.

_EN REALISING YOUR HOME

The most wonderful homes are those we feel in tune with, not only in the common areas (living room, kitchen, bathroom, patio...) but even in the more humble and utilitarian spaces, where we take care of our possessions and optimise our time. Washing and ironing in a functional or pleasurable environment, neatly putting away clothes, shoes and objects, and making the best use of every space. All of these things even in areas with more than one function, with versatile furniture that provides every day comfort, quality and uplifting emotions: thanks to Birex.

_DE EIN ZUHAUSE SCHAFFEN

Das schönste zuhause ist das, in dem wir uns nicht nur in den üblichen räumen (Wohnzimmer, Küche, Bad, Patio) heimisch fühlen, sondern auch in den bescheidensten und dienstbarsten, in denen wir uns um unsere Dinge kümmern und so unsere zeit optimieren. waschen und bügeln in einer funktionellen oder angenehmen Umgebung, aufräumen von Kleidung, schuhen und Gegenständen, Nutzung jedes Raums zum besten. All dies auch in einer Umgebung, die mehrere Funktionen gleichzeitig erfüllt, mit vielseitigen einrichtungen, die in der Lage sind, uns jeden Tag Komfort, Qualität und auch Emotionen zu bieten: dank Birex.

_FR DÉCORER LA MAISON

La plus belle maison est celle dans laquelle nous nous sentons en symbiose, et pas seulement dans les pièces principales (salon, cuisine, salle de bain, patio...) Mais également dans celles plus humbles et utiles, dans lesquelles nous pouvons prendre soin de ce qui nous appartient tout en optimisant notre temps. Laver et repasser dans un espace fonctionnel ou agréable, ranger soigneusement les vêtements, chaussures et objets, utiliser au mieux chaque espace. Tout ceci dans un lieu consacré à plusieurs fonctions simultanées, avec des meubles polyvalents, capables de nous fournir chaque jour, confort, qualité et émotions: en un mot, Birex.

_ES HACER CASA

La casa más hermosa es aquella que nos permite encontrarnos en sintonía no sólo con los espacios más canónicos (sala de estar, cocina, baño, patio...) Sino incluso en los más humildes y serviciales, en los que podemos curar nuestras cosas, optimizando nuestro tiempo. Lavar y planchar en un ambiente cómodo o acogedor, mantener en orden prendas, zapatos y objetos, aprovechar todo tipo de espacio de la mejor manera. Todo esto incluso en un ambiente pensado para más funciones al mismo tiempo, con muebles versátiles, capaces de otorgarnos día tras día comodidad, calidad e incluso emociones: gracias a Birex.

La casa in cui trovare spazio per le proprie esigenze e passioni.

BIREX HA STUDIATO TANTE SOLUZIONI ORIGINALI PER PRENDERCI CURA DI TUTTE LE COSE CHE DOBBIAMO O AMIAMO FARE. PERCHÉ LA VITA COMPRENDE TANTE NECESSITA' QUOTIDIANE: PULIRE, LAVARE, STIRARE, RIORDINARE. MA ANCHE TANTE PICCOLE E GRANDI PASSIONI, OGNUNA CON I SUOI SPAZI ED I SUOI OGGETTI. BIREX RENDE PIU' SEMPLICE, E DUNQUE PIU' BELLO, VIVERE TUTTI QUESTI MOMENTI: CON UN DESIGN CHE NON PASSA DI MODA ED UNA QUALITA' CHE DURA NEL TEMPO.

_EN A home with room for your needs and passions.

Birex has researched many unique solutions to help us perform everything we need to do and love to do. Because life involves many daily necessities: cleaning, washing, ironing, tidying. But also the multitudinous passions great and small, each involving a particular space and specific objects. Birex renders these moments more simple and therefore more beautiful: through design that never goes out of fashion and long lasting quality.

_DE Die Wohnung, die unseren Bedürfnissen und Passionen Raum bietet.

Birex hat viele neue Lösungen entwickelt, mit denen wir uns um alle Dinge kümmern können. Denn das Leben stellt uns täglich vor viele Aufgaben: putzen, waschen, bügeln, aufräumen. Doch es ist auch voller vieler kleiner und großer Freuden, jede mit ihren eigenen Räumen und Gegenständen. Birex macht es einfacher und darum schöner, all diese Momente zu leben mit einem Design, das nie aus der Mode kommt und einer zeitlosen Qualität.

_FR La maison dans laquelle trouver un espace pour chaque besoin et passion.

Birex a étudié de nombreuses solutions originales pour prendre soin de toutes les choses que nous devons et aimons faire. Parce que la vie implique de nombreuses nécessités quotidiennes : nettoyer, laver, repasser, ranger. Mais également de nombreuses passions, petites et grandes, chacune nécessitant espace et objets. Birex simplifie et embellit tous ces moments : avec un design toujours actuel et une qualité durable.

_ES Una casa donde hay espacio para nuestras exigencias y pasiones.

Birex ha ideado muchas soluciones originales para que podamos cuidar de todas las cosas que tenemos o que nos gustan hacer. Porque la vida hace sí que tengamos muchas necesidades cada día: limpiar, lavar, planchar, poner en orden. Pero también muchas pasiones pequeñas y grandes, cada una con sus espacios y objetos. Birex convierte estos momentos en algo de más sencillo, y por esto más hermoso: con un diseño que no pasa de moda y una calidad que dura en el tiempo.

La casa in cui sentirsi circondati da idee, attenzioni e soddisfazioni.

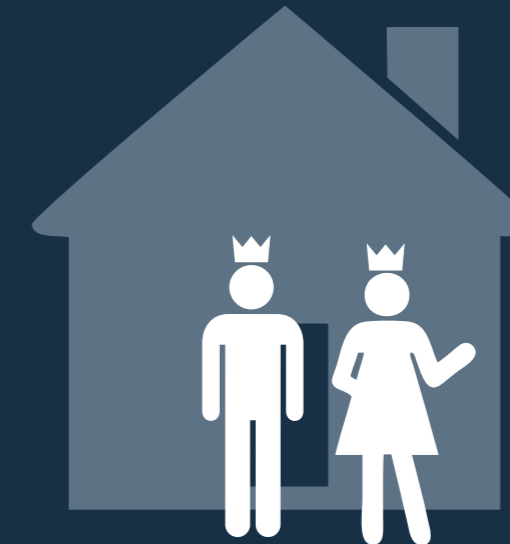

_EN A home where you feel surrounded by ideas, details and satisfaction.

_DE Die Wohnung, in der Sie sich von Ideen, Aufmerksamkeiten und Zufriedenheit umgeben fühlen.

_FR La maison où se sentir entouré d'idées, d'attention et de satisfaction.

_ES La casa en la que nos sentimos rodeados de ideas, atenciones y satisfacciones.



La qualità **BIREX,** punto per punto

_EN A home where you feel surrounded by ideas, details and satisfaction.

_DE Die Qualität von BIREX Punkt für Punkt.

_FR La maison où se sentir entouré d'idées, d'attention et de satisfaction.

_ES La casa en la que nos sentimos rodeados de ideas, atenciones y satisfacciones.



I PANNELLI UTILIZZATI SONO CONFORMI ALLA NORMATIVA CARB PHASE 2 CON BASSISSIME EMISSIONI FORMALDEIDE.

THE PANELS EMPLOYED ARE COMPLIANT WITH CARB PHASE 2, WITH LOW EMISSION OF FORMALDEHYDE.

IE VERWENDETEN PANEEL ENTSPRECHEN DER CARB 2-NORM MIT GERINGER FORMALDEHYDEMISSIONEN.

LES PANNEAUX UTILISÉS SONT CONFORMES AUX RÈGLEMENTS CARB PHASE 2 AVEC DE TRÈS FAIBLES ÉMISSIONS DE FORMALDÉHYDE.

LOS PANELES UTILIZADOS CUMPLEN CON EL ESTANDAR CARB 2 CON BAJA EMISIÓN DE FORMALDEHÍDO.



I PANNELLI UTILIZZATI SONO ECOSOSTENIBILI IN QUANTO REALIZZATI CON MATERIE PRIME RICICLATE E VERGINI DA RIFORESTAZIONE CONTROLLATA.

THE PANELS EMPLOYED ARE ECOLOGICAL SINCE MADE OF RECYCLED AND VERGIN RAW MATERIALS FROM REGULATED REFORESTATION.

DIE VERWENDETEN PANEEL SIND ÖKOLOGISCH NACHHALTIG, DA SIE AUS REYCELTEN UND UNBEHANDELTEN ROHSTOFFEN AUS KONTROLLIERTER WIEDERAUFFORSTUUNG HERGESTELLT WERDEN.

LES PANNEAUX UTILISÉS SONT RESPECTUEUX DE L'ENVIRONNEMENT CAR ILS SONT FABRIQUÉS À PARTIR DE MATIÈRES PREMIÈRES RECYCLÉES ET VIERGES D'UN REBOISEMENT CONTRÔLÉ.

LOS PANELES UTILIZADOS SON ECO-SOSTENIBLES YA QUE ESTÁN HECHOS CON MATERIAS PRIMAS RECICLADAS Y VÍRGENES DE REFORESTACIÓN CONTROLADA.



PANNELLI CON BORDATURA POLIURETANICA IDROREPELLENTE CERTIFICATA.

PANELS WITH POLYURETHANE, CERTIFIED WATERPROOF EDGING.

PANEEL MIT ZERTIFIZIERTER WASSERABWEISENDER POLYURETHANKANTE.

PANNEAUX AVEC BORDURE EN POLYURÉTHANE HYDROFUGE CERTIFIÉ.

PANELES CON BORDES CERTIFICADOS DE POLIURETANO REPELENTE AL AGUA.



LACCATURA OPACA, SATINATA E ANTIGRAFFIO REALIZZATA CON VERNICI A BASE ACQUA E MATERIE PRIME DI ORIGINI VEGETALI.

MATT, SATIN, SCRATCH-RESISTANT LACQUER MADE OF WATER-BORNE PAINTS AND PLANT-RELATED RAW MATERIALS.

MATTES UND KRATZFESTES LACKIERUNG MIT WASSERLACKE UND ROHSTOFFEN PFLANZLICHEN URSPRUNG.

LAQUE MATTE, SATINÉE ET ANTIRAYURES À BASE DE PEINTURES À L'EAU ET DE MATIÈRES PREMIÈRES VÉGÉTALES.

ACABADO MATE Y RESISTENTE A LOS ARAÑAZOS CON BARNICES AL AGUA Y MATERIAL PRIMAS DE ORIGEN VEGETAL.



PRODUZIONE CERTIFICATA 100% MADE IN ITALY.

CERTIFIED 100% MADE IN ITALY PRODUCTION.

ZERTIFIZIERTE PRODUKTION 100% MADE IN ITALY.

PRODUCTION CERTIFIÉE 100% MADE IN ITALY.

PRODUCCIÓN CERTIFICADA 100% MADE IN ITALY.



SISTEMA DI GESTIONE DELLA QUALITÀ CERTIFICATA ISO 9001.

CERTIFIED ISO 9001 QUALITY MANAGEMENT SYSTEM.

QUALITÄTSMANAGEMENTSSYSTEM ZERTIFIZIERT ISO 9001.

SYSTÈME DE GESTION DE LA QUALITÉ CERTIFIÉ ISO 9001.

SISTEMA DE GESTIÓN DE CALIDAD CERTIFICADO ISO 9001.

index

LAVANDERIE

/LAUNDRIES

page 10

IDROBOX

page 12

ACQUA e SAPONE

page 88

LAVATOI

page 114

CONTENITORI

/CONTAINERS

page 124

XBOX

page 126

BRACCIO DI FERRO

page 142

**PIANI INTEGRATI
VASCHE LAVATOIO**

page 154

FINITURE

page 164



LAVANDERIE

/LAUNDRIES

CASE PICCOLE O GRANDI, SINGLE O FAMIGLIE NUMEROSE: TUTTI HANNO BISOGNO DI ORGANIZZARE UNO SPAZIO LAVANDERIA IDEALE. PUO' ESSERE UN ANGOLO NEL BAGNO O DI UN AMBIENTE APPOSITO: L'IMPORTANTE E' CHE SIA ORDINATO, FUNZIONALE, INTELLIGENTE E MAGARI - PERCHE' NO? - PIACEVOLE.

_EN Small or large homes, from singles to large families: everyone needs to arrange an ideal laundry area. Be it a corner in the bathroom or a dedicated room: what's important is that it's well organised, functional, intelligent and also - why not? - Pleasant.

_DE Ob kleine oder große Wohnungen, Single oder Großfamilie: alle müssen einen idealen Waschbereich organisieren. Es kann eine Eicke im Bad sein oder ein eigener Raum: das wichtige ist, dass er ordentlich, funktionell, intelligent und - warum nicht? - angenehm ist.

_FR petites ou grandes maisons, célibataires ou familles nombreuses: chacun a besoin d'un espace buanderie adapté. Il peut s'agir d'un angle de la salle de bains ou d'un lieu spécialement consacré: l'important est qu'il soit ordonné, fonctionnel, intelligent et pourquoi pas... Agréable.

_ES casas pequeñas o grandes, soltero o familias numerosas: todos necesitan organizar un espacio lavandería ideal. Puede ser un rincón del baño o un espacio especial: lo importante es que esté ordenado, sea cómodo, inteligente y - por qué no? - Agradable.



IDROBOX

Design Birex

UN SISTEMA POLIEDRICO CHE PERMETTE DI CREARE LE PIU' DIVERSE SOLUZIONI PER LAVARE, ASCIUGARE E STIRARE, INSERENDOSI IN OGNI SPAZIO: DAL PICCOLO RIPOSTIGLIO, ALL'AMBIENTE BAGNO, AD UNA VERA E PROPRIA LAVANDERIA DOMESTICA.

_EN Modular laundry furniture that can satisfy all your needs in a multi-faceted design that can be fit in small spaces e.g., bathroom or closet, or used to organize a dedicated home laundry with basin, washing machine housing, ironing board, clothes rack and other necessities.

_DE Einbaueinrichtungen für den Waschmaschinenbereich, gestatten es, allen Anforderungen gerecht zu werden, ein vielseitiges Programm, das auf begrenztem Raum wie z. B. im Bad oder der Abstellkammer Platz findet oder eine echte Haushaltswaschküche mit Waschtisch, Waschmaschinenschrank, Bügeleisen, Wäscheständer und was sonst notwendig ist einrichten kann.

_FR Les meubles modulaires destinés aux buanderies permettent de répondre à tous les besoins. Il s'agit d'un programme multi-facettes adapté aux petits espaces tels que la salle de bains ou un placard, ou encore permettant d'organiser une véritable buanderie domestique avec lavabo, meuble machine à laver, planche à repasser, étendoir et tout le nécessaire.

_ES Muebles de lavandería componibles, permiten satisfacer todas las exigencias, es un programa poliédrico que se puede colocar en espacios pequeños, p.ej. baño, trastero u organizar una lavandería doméstica con lavadero, sitio para la lavadora, tabla de planchar, tendedero y todo lo necesario.

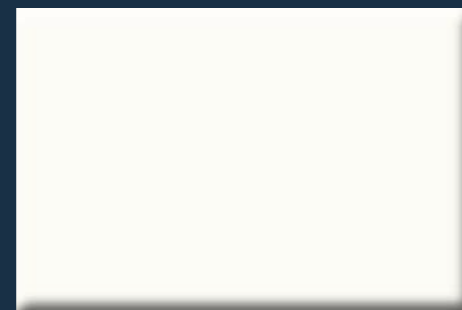

_Laccato opaco Bianco 9003

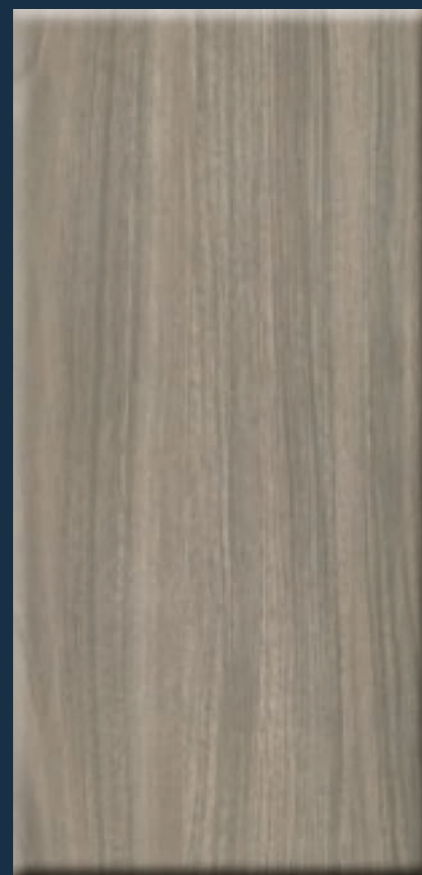

_Olmo grey 039

**Personalità
estetica per
un'esterna
versatilità.**

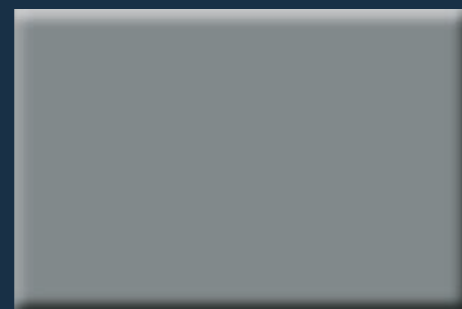

_Laccato opaco Carta da zucchero Y23923

_EN Aesthetic personality for an external versatility.

_DE Ästhetische Persönlichkeit für externe Vielseitigkeit.

_FR personnalité esthétique pour une polyvalence externe.

_ES Eronalidad estética para una versatilidad externa.



NUOVA BASE PORTA LAVATRICE ANTE A SOFFIETTO

- _EN New washing machine base with folding doors.
- _DE Neuer Waschmaschinenschrank mit Falttüren.
- _FR Nouvelle base porte machina à laver avec portes pliantes.
- _ES Nueva base para lavadora con puertas plegables.



COMP. 1 L.300 P.60/70 H.200



COLONNA ANTA BATTENTE PORTA SCARPE E STIVALI CON IGIENIZZATORE DELL'ARIA

- _EN Shoe-boots tall unit with hinged door and air treatment device.
- _DE Hochschrank mit drehtüt für schuhe und tiefel mit luftreiniger.
- _FR Colonne porte battante porte chaussures et bottes avec assainissement d'air.
- _ES Columna puerta batiente para zapatos y botas con desinfectante para el aire.



NUOVO ELEMENTO A GIORNO L. 45 CM

- _EN New open element w. 45 cm.
- _DE Neues, offene Regal B. 45 cm.
- _FR Nouveau élément ouvert L. 45 cm.
- _ES Nuevo elemento abierto a. 45 cm.

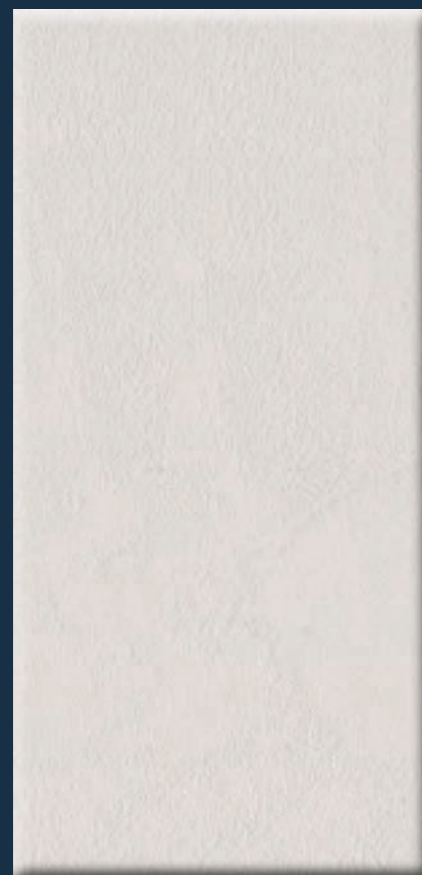

_Malta ghiaccio 015

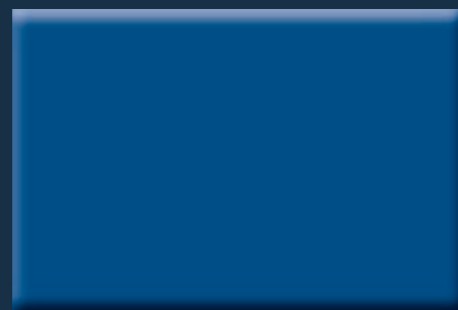

_Laccato opaco Blu genziana 5010

**Su misura
per inserirsi
in qualsiasi
spazio.**

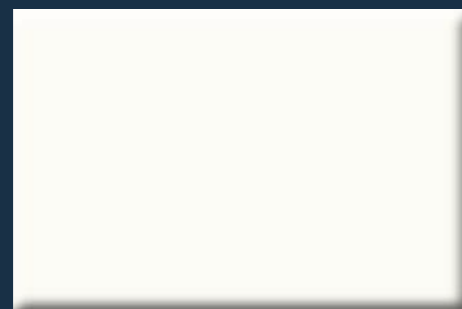

_Laccato opaco Bianco 9003

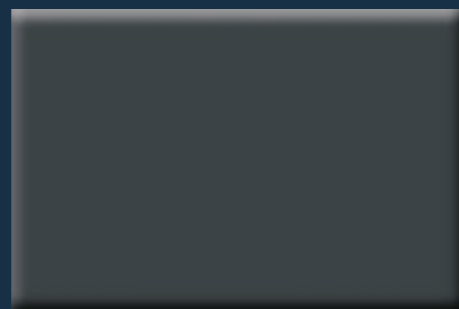

_Laccato opaco Grigio antracite 7016

_EN Custom-made to fit any space.

_DE Auf jeden Raum zugeschnitten.

_FR sur mesure pour s'adapter
à n'importe quel espace.

_ES Adaptado para encajar
en cualquier espacio.





**PENSILE A GIORNO CON FIANCHI
IN METALLO VERNICIATO**

- _EN Open wall unit with sides in metal varnished finish.
- _DE Offenes Wandregal mit lackierten Metallseiten.
- _FR Module suspendu ouvert avec joues en métal vernis.
- _ES Colgante abierto con laterales de metal barnizado.



**NUOVO LAVATOIO IN
MARMO MINERALE L 45 CM**

- _EN New mineral marble washbasin w. 45 cm.
- _DE Neuer Waschtrog aus Mineralmarmo B. 45 cm.
- _FR Nouveau lavabo en marbre minéral L 45 cm.
- _ES Nuevo lavado en mineralmarmo a. 45 cm.

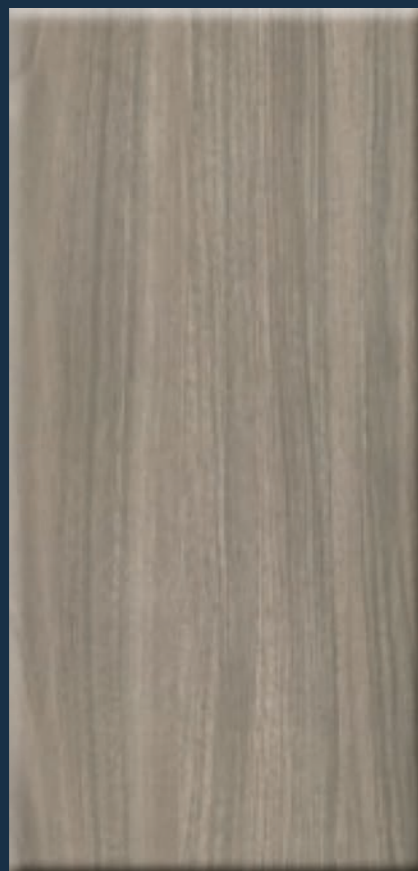

_Olmo grey 039

**Continuità
ed equilibrio
tra superfici
diverse.**



_Laccato opaco Blu piombo 255

_EN Continuity and balance between different surfaces.

_DE Kontinuität und Gleichgewicht zwischen verschiedenen Oberflächen.

_FR Continuité et équilibre entre les différentes surfaces.

_ES Continuidad y equilibrio entre diferentes superficies.





NUOVA COLONNA CON VANO A GIORNO LATERALE

- _EN New tall unit with side open unit.
- _DE Neuer Hochschrank mit offenem Seitenfach.
- _FR Nouvelle colonne avec espace ouvert latéral.
- _ES Nueva columna con compartimiento lateral abierto.





_Olmo white 038

Minimalismo dalla grande personalità.

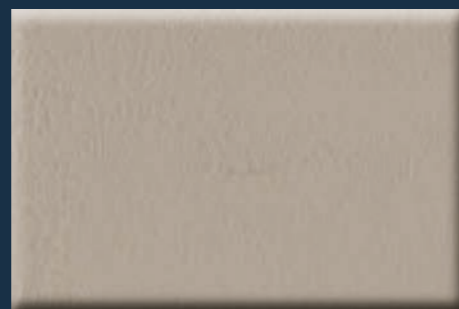

_Malta tortora 016

_EN Minimalism with great personality.

_DE Minimalismus mit großer Persönlichkeit.

_FR Minimalisme de la grande personnalité.

_ES Minimalismo con gran personalidad.





**COMODO PIANO DI LAVORO
COPRI LAVATRICE**

..EN Handy washing machine cover worktop.
..DE Komfortable arbeitsplatte-waschabdeckung.
..FR Plan de travail, a couverture de la machine
a laver, pratique.
..ES Cómodo plano de trabajo encima de
lavadora.



COMP. 4 L.180+255 P.60 H.200

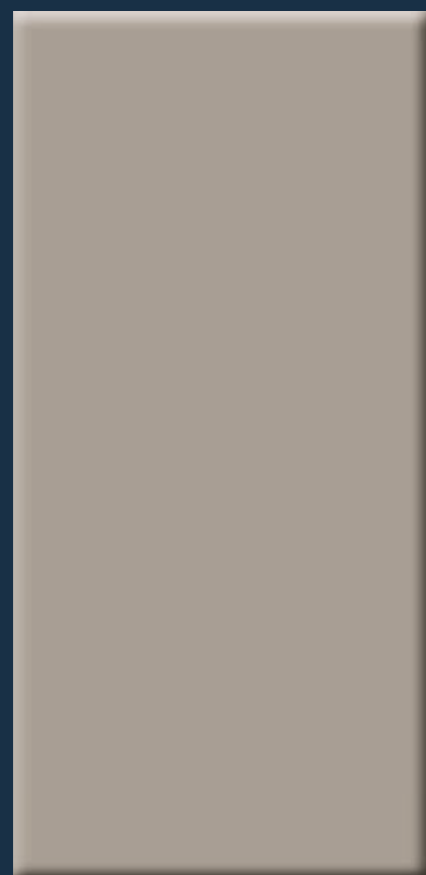

_Laccato opaco Corda 061

Interpretare le esigenze del tuo quotidiano.

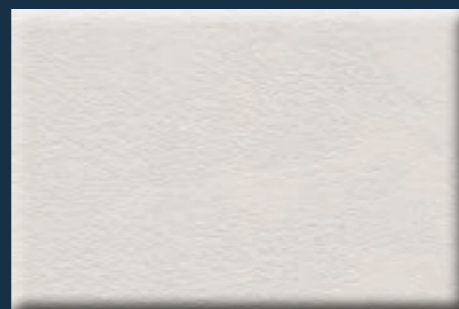

_Malta ghiaccio 015

_EN Interpreting everyday need.

_DE Die Bedürfnisse des täglichen Lebens interpretieren.

_FR Interpréter les besoins de votre vie quotidienne.

_ES Interpretar las necesidades de la vida diaria.





**NUOVO LAVABO/LAVATOIO
IN CERAMICA**

- EN New laundry unit with ceramic wash basin.
- DE Neuer Waschbecken/Waschtrog aus Keramik.
- FR Nouveau lavabo/lavoir en céramique.
- ES Nuevos muebles lavabo de cerámica.



COMP. 5 L.330 P.60 H.200



_Laccato opaco Verde petrolio 5021

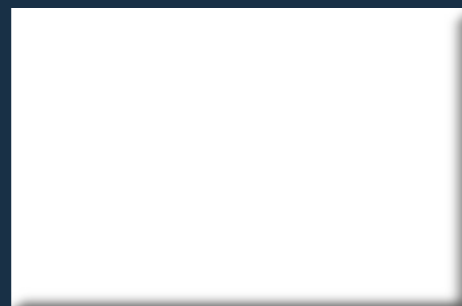

_Melaminico Bianco 050

**Pulizia di
forme per
una moderna
funzionalità.**

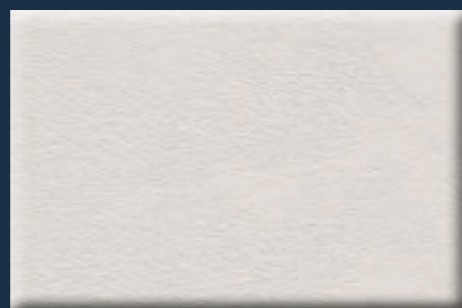

_Malta ghiaccio 015

_EN Clean-cut shapes for a modern functionality.

_DE Saubere Formen für eine moderne Funktionalität.

_FR Nettoyage des formes pour une fonctionnalité moderne.

_ES Formas limpias para una funcionalidad moderna.





**NUOVO ELEMENTO BASE
A GIORNO IN FINITURA
MALTA GHIACCIO**

- _EN New open base element in Ghiaccio resin effect.
- _DE Neues offenes Unterteil in Ausführung Betoneffekt ghiaccio.
- _FR Nouveau élément base ouvert en finition Malta Ghiaccio.
- _ES Nueva base abierta en acabado efecto resina ghiaccio.



_Laccato opaco Verde pompelmo 192

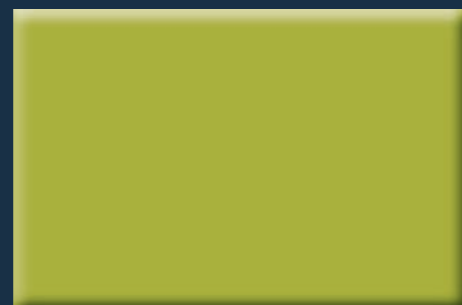

**L'estetica non
è mai separata
dalla funzione.**

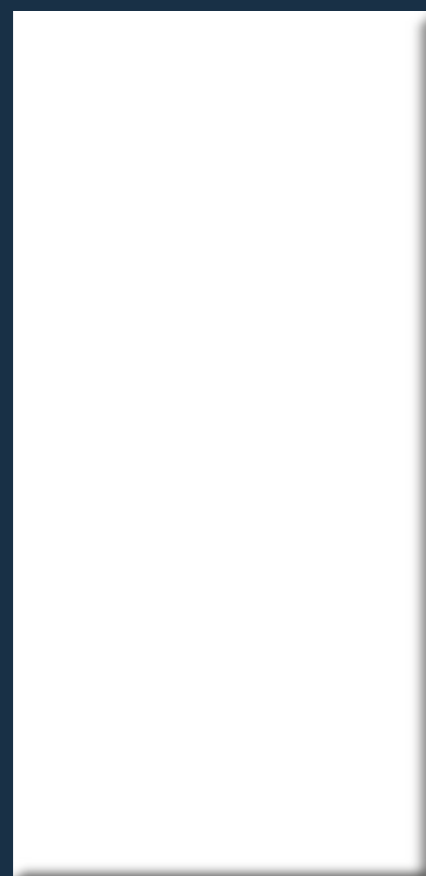

_Melaminico Bianco 050

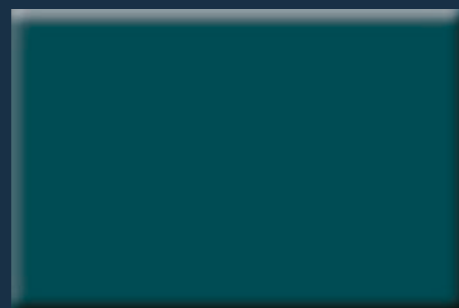

_Laccato opaco Verde finlandia 199

_EN Aesthetics is never separated from functionality.

_DE Ästhetik ist nie von Funktion getrennt.

_FR L'esthétique n'est jamais séparée de la fonction.

_ES La estética nunca se separa de la función.



**PORTA-LAVATRICE CON ANTE
APERTURA 270°**

_EN Washing machine base supplied with 270° opening doors.
_DE Waschmaschinenschrank mit 270° öffnenden Türen.
_FR Porte machine à laver avec porte ouverture 270°.
_ES Mueble para lavadora con puertas de apertura de 270°.



_IT Nuovo lavatoio grandi dimensioni
 L. 65 P.45 H. 28/11 cm.
 _EN New laundry unit with big dimensions
 W.65 D. 45 H.28/11 cm.
 _DE Neue Waschtrog von grossem
 Ausmass B.65 T.45 H.28/11 cm.
 _FR Nouveau lavoit grandes dimensions
 L.65P45 H.28/11.
 _ES Nuevo mueble para lavado de gran
 tamaño A.65 P.45 H.28/11 cm.



_IT Lavabo h.11 cm.
 _EN Washbasin h.11 cm.
 _DE Waschbecken H.11 cm.
 _FR Lavabo h.11 cm.
 _ES Lavabo H.11 cm.



_IT Lavatoio con asse in Marmo Mineral.
 _EN Laundry unit with Mineral Marble board.
 _DE Waschtrog mit Brett aus Marmo Minerale.
 _FR Lavoit avec planche en Marbre minéral.
 _ES Mueble para lavado con tabla de Marmo
 Minerale.



COMP. 7 L.240 P.60 H.214

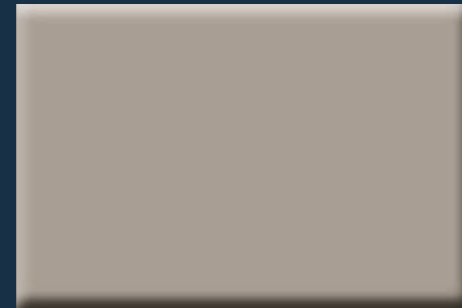

_Laccato opaco Corda Y20261

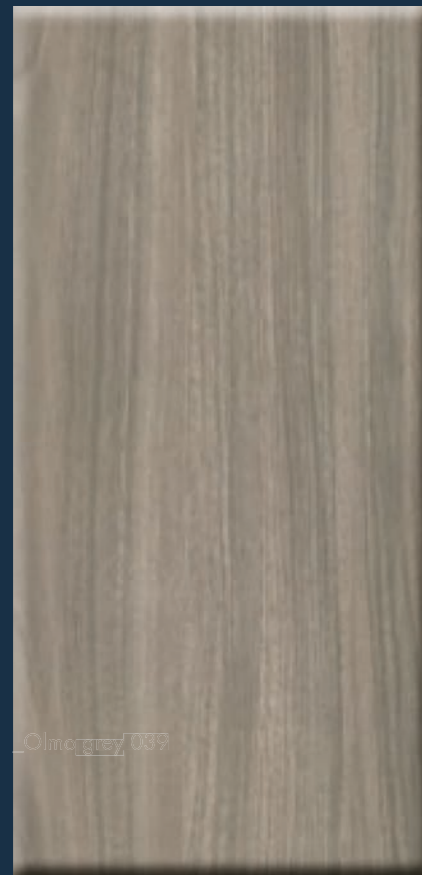

_Olmo grey 039

Libertà di scelta per molteplici combinazioni.

_EN Freedom of choice for multiple combinations.

_DE Wahlfreiheit für mehrere Kombinationen.

_FR Liberté de choix pour plusieurs combinaisons.

_ES Libertad de elección para combinaciones múltiples.



_IT Colonna lavatrice/asciugatrice con nuovo sistema di apertura a 180°/270°.

_EN Tall unit with washing machine/tumble dryer provided with a new 180°/270° opening system.

_DE Hochschrank für Waschmaschine/Waschtrockenapparat mit neuem Öffnungssystem 180°/270°.

_FR Colonne pour machine à laver/séchoir avec nouveau système d'ouverture 180°/270°.

_ES Columna para lavadora/secadora con nuevo sistema de apertura de 180°/270°.



- **_IT** Nuovo lavatoio grandi dimensioni
L. 65 P.45 H.28 cm.
- **_EN** New laundry unit with big dimensions
W.65 D.45 H.28 cm.
- **_DE** Neue Waschtrog von grossem
Ausmass B.65 T.45 H.28 cm.
- **_FR** Nouveau lavoir grandes dimensions
L.65 P.45 H.28.
- **_ES** Nuevo mueble para lavado de gran
tamaño A.65 P.45 H.28 cm.



**FONDO RIVESTITO
ALLUMINIO DI SERIE
SU BASI LAVABO**

- **_EN** Aluminium protection leaf on the
bottom of the unit as a standard
equipment of washbasin bases.
- **_DE** Unterboden der Waschbeckenunterteile
serienmässig mit Aluminium verkleidet.
- **_FR** Fond avec protection en aluminium
sur toutes les bases lavabo.
- **_ES** Fondo de la base para lavadora
estándar con revestimiento de aluminio.



_Olmo white 038

Esempio di geometria per infinite soluzioni.

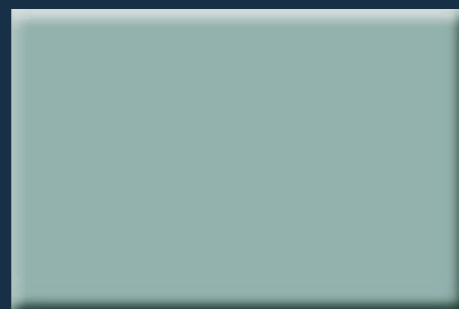

_Laccato opaco Grigio garda 246

_EN Example of arrangement for endless solutions.

_DE Geometrie für unendlich viele Lösungen.

_FR Exemple de géométrie pour des solutions infinies.

_ES Ejemplo de geometría para soluciones infinitas.



_IT Nuova colonna asse da stiro con anta apertura 180°/270° e luce led.

_EN New tall unit equipped with ironing board, door with 180°/270° opening system and led light.

_DE Neuer Hochschrank mit Bügelbrett Öffnung 180°/270° und Ledleuchte.

_FR Nouvelle colonne, planche à repasser avec porte ouverture 180°/270° et éclairage led.

_ES Nueva columna con tabla de planchar, apertura 180°/270° y luz led.



COMP. 9 L.227+260 P.60 H.200

**CAPIENTE COLONNA
ANGOLARE**

- EN** Spacious corner tall unit.
- DE** Eckschrank von grosser Kapazität.
- FR** Grande colonne angle.
- ES** Columna ángulo de gran capacidad.



_016 Malta tortora

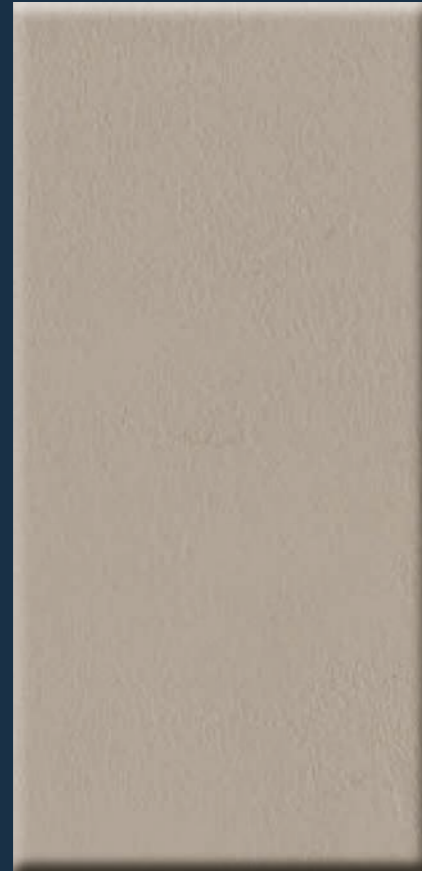

Funzionalità e razionalità dello spazio.



_Melaminico Bianco 050

_EN Functionality and rationality of space.

_DE Funktionalität und Rationalität des Raumes.

_FR Fonctionnalités et rationalité e l'espace.

_ES Funcionalidad y racionalidad del espacio.



_IT Nuova base portalavatrice con carica dall'alto.

_EN New washing machine base unit with top loading.

_DE Neues Unterteil für Waschmaschine mit Toplader.

_FR Nouvelle base pour machine à laver chargement par-dessus.

_ES Nueva base para lavadora de carga arriba.



**CAPIENTE CESTO PORTA
BIANCHERIA ESTRAIBILE/
ASPORTABILE**

- _EN Spacious extractable laundry basket/
removable.
- _DE Ausziehbarer/Abnehmbarer
Waschenkorb von grosser Kapazität.
- _FR Grande panier à linge extractible et
amovible.
- _ES Gran cesto para ropa sucia extraíble/
desmontable.

**NUOVO LAVABO/LAVATOIO
IN CERAMICA**

- _EN New laundry unit with ceramic wash basin.
- _DE Neuer Waschbecken/Waschtrog aus Keramik.
- _FR Nouveau lavabo/lavoir en céramique.
- _ES Nuevos muebles lavabo de cerámica.



COMP. 10 L. 240 P.50/70 H.200



_Olmo white 038

Soluzioni innovative garantiscono l'ordine.

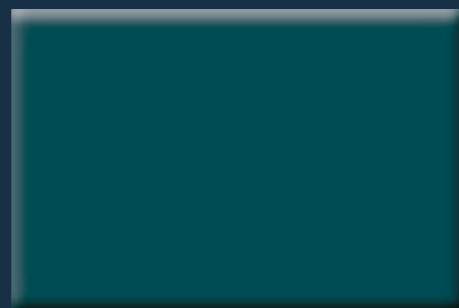

_Laccato opaco Verde Finlandia 199

_EN Original solutions that guarantee order.

_DE Innovative Lösungen garantieren Ordnung.

_FR Les solutions innovantes garantissent l'ordre.

_ES Soluciones innovadoras que garantizan el orden.



_IT Colonna lavatrice/asciugatrice con sistema di apertura a soffietto.

_EN Tall unit with washing machine/tumble dryer provided with folding door system.

_DE Hochschrank für Waschmaschine/Waschtrockenapparat mit Falttüren.

_FR Colonne machine à laver/séchoir avec ouverture pliante.

_ES Columna para lavadora/secadora con puertas plegables.



COMP. 11 L.302+227 P.60 H.260

CAPIENTE BASE ANGOLARE

- EN Spacious corner base.
- DE Eckunterteil von grosser Kapazität.
- FR Grande base angle.
- ES Base ángulo de gran capacidad.



_Laccato opaco Verde pompelmo 192

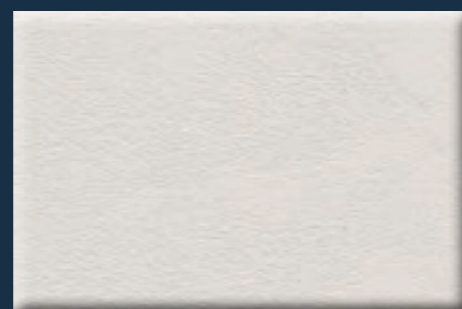

_Malta ghiaccio 015

Strutture pensate per le tue esigenze.

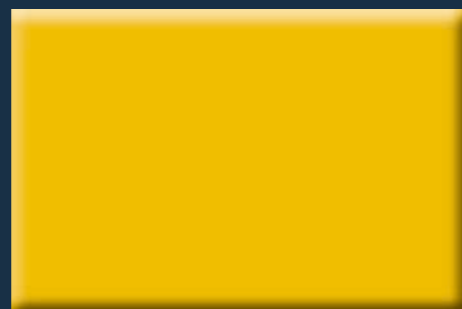

_Laccato opaco Giallo cromo 140

_EN Structures designed to meet your requirements.

_DE Einrichtungen, die auf ihre Bedürfnisse zugeschnitten sind.

_FR Des structures conçues pour vos besoins.

_ES Estructuras diseñadas para sus necesidades.



_IT Pratico cassettone portabiancheria estraibile.

_EN Handy extractable laundry drawer.

_DE Funktioneller, ausziehbarer Waschenkorb.

_FR Panier à linge extractible pratique.

_ES Práctico cesto para ropa sucia, extraíble.



**CASSETTI METALLICI ESTRAZIONE
TOTALE CHIUSURA RALLENTATA**

- _EN Metallic drawers with full-extraction and soft closure track system.
- _DE Metallische Laden mit Vollauszug und gedämpfter Schliessung.
- _FR Tiroirs métallique sortie totale et fermeture ralentie.
- _ES Cajones metálicos con guías de apertura total y cierre amortiguado.



COMP. 12 L.270+225 P.60 H.200

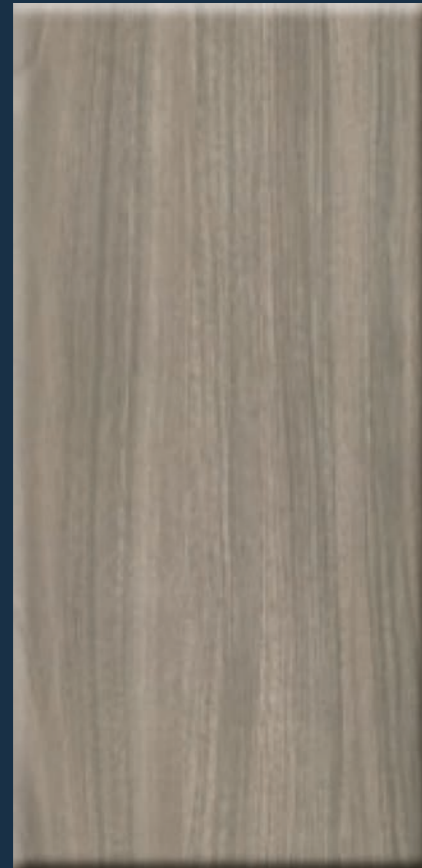

_Olmo grey 039

Pieni e vuoti
con un'unico
obiettivo:
contenere.

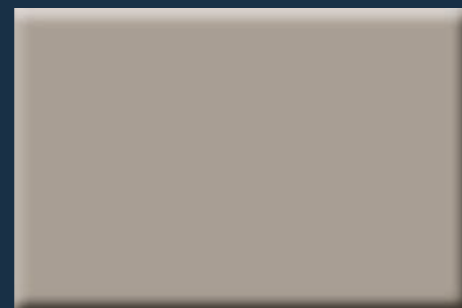

_Laccato opaco Corda Y20261

_EN Open and closed elements
with one single goal: storing.

_DE Voll und leer mit einem
einzigem Ziel: enthalten.

_FR Plein et vide avec
un seul but: contenir.

_ES Leno y vacío con un solo
objetivo: contener.



_IT Cassettone su ruote.
_EN Laundry baskets on rollers.
_DE Große Schubladen auf Rädern.
_FR Grands tiroirs sur roulettes.
_ES Cajones con ruedas.



COMP. 13 L.330 P.60/70 H.200

IDROBOX/LAUNDRIES

- _IT Programma modulare per lo spazio lavanderia.
- _EN Modular laundry space arrangements.
- _DE Modulares Programm für den Waschmaschinenbereich.
- _FR Programme modulaire pour la buanderie.
- _ES Programa modular par el espacio lavandería.

COLONNE PORTA LAVATRICE/ACIUGATRICE

- _EN Washing machine/dryer vertical unit.
- _DE Hochschranke für Waschmaschine/Wäschetrockner.
- _FR Colonnes meuble machine à laver/séchoir à linge.
- _ES Columnas para la Lavadora/Secadora.

L. 75/150 cm
P. 60/70 cm
H. 200 cm

PANCA PORTALAVATRICE

- _EN Washing machine housing bench.
- _DE Waschmaschinenbank.
- _FR Banc porte-machine à laver.
- _ES Banco para la Lavadora.

L. 75 cm
P. 70 cm
H. 44 cm

PANCA

- _EN Bench.
- _DE Bank.
- _FR Banc.
- _ES Banco.

L. 120/135/150/180 cm
P. 50/60/70 cm
H. 44 cm

CASSETTI SU RUOTE

- _EN Drawers on rollers.
- _DE Schubladen auf Rädern.
- _FR Tiroirs sur roulettes.
- _ES Cajones de ruedas.

L. 56/66/71/81 cm
P. 50 cm
H. 37 cm

PIANO "PONTE"

- _EN Bridge element.
- _DE Brückes Element.
- _FR Élément à pont.
- _ES Elemento à puente.

L. max 270 cm
P. 50/60/70 cm
H. 96 cm

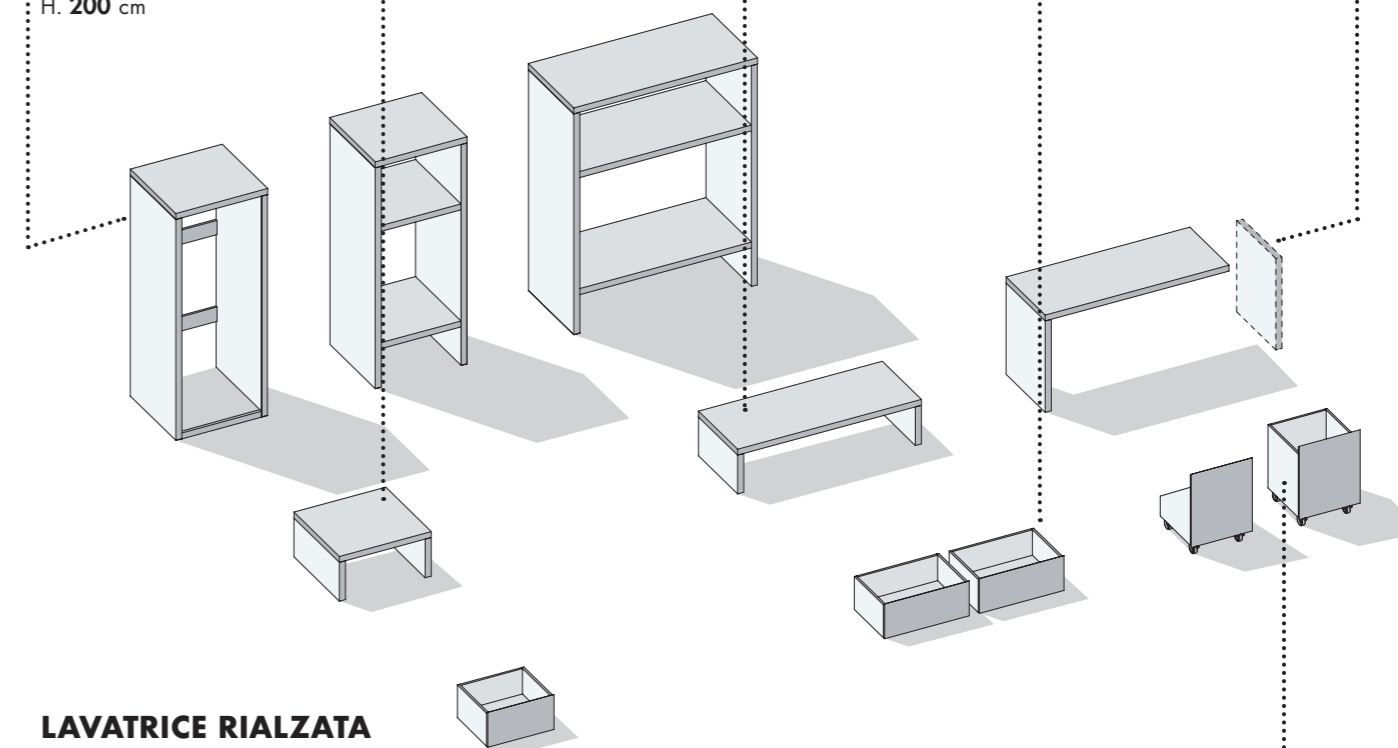

LAVATRICE RIALZATA DA TERRA DI 44 CM

- _EN Raised washing machine 44 cm above ground.
- _DE Waschmaschine 44 cm über dem Boden.
- _FR Machine à laver surélevée du sol de 44 cm.
- _ES Lavadora levantada del suelo de 44 cm.

CONTENITORI SU RUOTE

- _EN Cabinets en wheels.
- _DE Schrank mit Rad.
- _FR Conteneurs on roulettes.
- _ES Contenedor con ruedas.

L. 60 cm
P. 60 cm
H. 92 cm



_Laccato opaco Canapa Y20259

Ricerca ed
estetica per
soddisfare
le esigenze.

_EN Research and aesthetics
to meet any requirement.

_DE Forschung und Ästhetik,
um die Bedürfnisse zu erfüllen.

_FR Recherche et esthétique
pour répondre aux besoins.

_ES Investigación y estética para
satisfacer las necesidades.



CESTO ESTRAIBILE PER BASE
(optional)

_EN Extractable basket for bases (optional).
_DE Ausziehbarer Korb für Unterschrank (Option).
_FR Panier extractible pour meuble bas (en option).
_ES Cesta extraíble para base(opcional).



IDROBOX/LAUNDRIES

COMP. 14 L.135 P.70 H.200

SPECCHIERA CONTENITORE

- EN Mirror unit Container.
- DE Spiegelschrankbehälter.
- FR Miroir sur meuble de rangement.
- ES Espejo Contenedor.



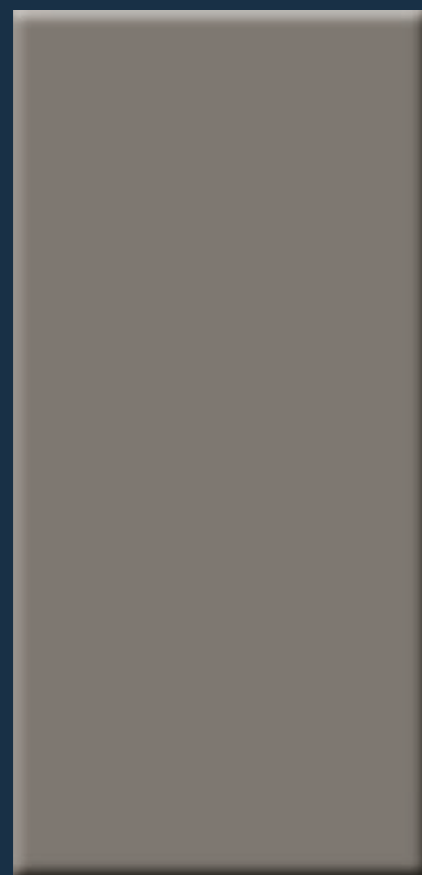

_Laccato opaco Dark grey Y18232

**Volumi studiati
per facilitare
l'inserimento
negli spazi.**

_EN Studied volumes to perfectly fit in any space.

_DE Volumen, die das Einfügen in Räume erleichtern sollen.

_FR Volumes conçus pour faciliter l'insertion dans les espaces.

_ES Volúmenes diseñados para facilitar la inserción en los espacios.





IDROBOX/LAUNDRIES

COMP. 15 L.120 P.35/50 H.200

PIANO CON LAVATOIO INTEGRATO E CAMBIO PROFONDITA'

- _EN Top with integrated washbasin and different depth.
- _DE Platte mit integriertem waschtisch und tiefwechsel.
- _FR Plan avec lavabo intégré et double profondeur.
- _ES Top con lavabo integrado y cambio profundidad.



ANTA CON MANIGLIA A GOLA

- _EN Door with grip handle.
- _DE Tür mit versenktem Griff.
- _FR Porte avec poignée à rainure.
- _ES Puerta con tirador empotrado.

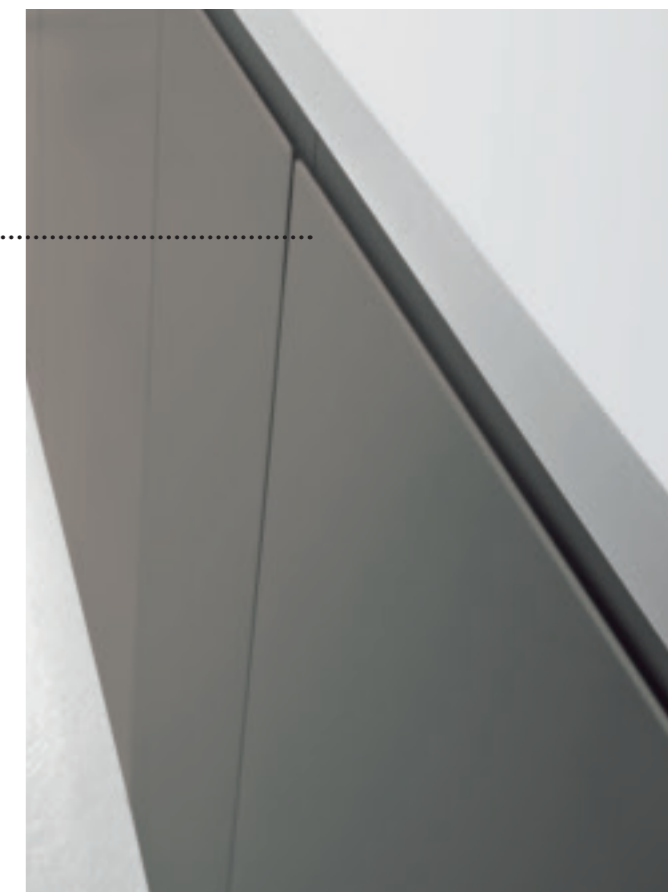

Linee
sinuose
per forme
eleganti.

_Laccato opaco Terracotta Y23919

_EN Sinuous lines for elegant shapes.

_DE Geschwungene Linien für elegante Formen.

_FR Lignes sinueuses pour des formes élégantes.

_ES Líneas sinuosas para formas elegantes.





IDROBOX/LAUNDRIES

COMP. 16 L.195 P.35/60 H.200

CASSETTONE SAGOMATO CON MANIGLIE A GOLA

- _EN Shaped drawer with grip profile handle.
- _DE Geformter Schubkasten mit eingebautem griff.
- _FR Grand tiroir galbe avec poignée gorge.
- _ES Gaveta moldeada con tirador integrado.



**SPECCHIO CONTENITORE
CON APERTURA
BASCULANTE**

EN Voluminous Mirror container with tilt tray.

DE Großzügiger Spiegelschrank mit Klappe.

FR Grand miroir de rangement avec ouverture pivotante.

ES Espejo grande con contenedor con apertura basculant.

L.60 P.20 H.60 cm



IDROBOX - LE APERTURE



Ante battenti 105°.
 _EN Hinged doors with 105° opening system.
 _DE Drehtüren 105.
 _FR Portes battantes 105°.
 _ES Puertas batientes 105°.



Ante battenti 180°/270°.
 _EN Hinged doors with 180°/270° opening system.
 _DE Drehtüren 180°/270°.
 _FR Porte battantes 180°/270°.
 _ES Puertas batientes 180°/270°.



- Cassetti metallici estrazione totale chiusura rallentata.
 _EN Metallic drawers with full-extraction and soft closure track system.
 _DE Metallische Laden mit Vollauszug und gedämpfter Schliessung.
 _FR Tiroirs métallique sortie totale et fermeture ralentie.
 _ES Cajones metálicos con guías de apertura total y cierre amortiguado.



Anta a 45° con presa a gola.
 _EN 45° cut door with grip opening.
 _DE Tür mit Abschrägung 45° und Auskehlung.
 _FR Porte à 45° avec prise de main.
 _ES Puertas con cantos de 45° y uñero.



Ante soffietto.
 _EN Folding door.
 _DE Falttüren.
 _FR Portes pliantes.
 _ES Puertas plegables.



Cerniera con chiusura ammortizzata integrata a scomparsa Salice.
 _EN Soft-closure built-in Salice hinge.
 _DE Scharnier mit versteckter, gedämpfter Schliessung SALICE.
 _FR Charnières avec fermeture ralentie intégré et invisible Salice.
 _ES Bisagra con cierre amortiguado integrado oculto SALICE

COLONNA CON ASSE DA STIRO ESTRAIBILE ED ANTA APERTURA 270°

- _EN Tall unit with extractable ironing board and doors w/270° opening.
- _DE Hochschrank mit ausziehbarer bügelbrett und 270° öffnender tür.
- _FR Colonne avec planche a repasser extractible et porte ouverture 270°.
- _ES Columna con tabla de planchar extraíble y puerta apertura 270°.

COLONNA CON APPENDIABITI ESTRAIBILE E CASSETTI

- _EN Tall unit with extractable clothe hanger and drawers.
- _DE Hochschrank mit abnehmbaren kleiderbügel und schubladen.
- _FR Colonne avec tringle extractible et tiroirs.
- _ES Columna con perchero extraíble y cajones.

COLONNA PORTA SCARPE ANTA RIBALTA

- _EN Shoe tall unit with flap door.
- _DE Schuhrack mit klapptür.
- _FR Colonne porte chaussures porte abattant.
- _ES Columna porta zapatos con puerta abatible.

COLONNA PORTA SCOPE

- _EN Tall unit with broom storage compartment.
- _DE Schrank mit fach für besen.
- _FR Colonne porte balais.
- _ES Columna porta escobas.

COLONNA ATTREZZATA CON DOPPIO CESTO, CASSETTO E ANTA A RIBALTA

- _EN Equipped tall unit w/double basket, drawer and flap door.
- _DE Hochschrank mit doppelkorb, schublade und klappentür.
- _FR Colonne equipee avec double panier, tiroir et porte abattant.
- _ES Columna con doble cesta, cajón y puerta abatible.

COLONNA CON RIPIANI SAGOMATI

- _EN Tall unit with shaped shelves.
- _DE Hochschrank mit geformten böden.
- _FR Colonne avec etageres galbes.
- _ES Columna con estantes moldeados.

COLONNA CON CESTI ESTRAIBILI E PORTABIANCHERIA

- _EN Tall unit with extractable baskets and laundry one.
- _DE Hochschrank Mit Ausziehbaren Körben Und Waschkorb.
- _FR Colonne avec paniers extractibles et panier a linge.
- _ES Columna con cestas extraíbles y compart.para ropa.

COLONNA ANTA BATTENTE PORTA SCARPE E STIVALI

- _EN Shoe-boots tall unit with hinged door.
- _DE Hochschrank mit drehtüt für schuhe und stiefel.
- _FR Colonne porte battante porte chaussures et bottes.
- _ES Columna puerta batiente para zapatos y botas.



**COLONNA CON ASSE
DA STIRO ESTRAIBILE ED
ANTA APERTURA 270°**

- _EN Tall unit with extractable ironing board and doors w/270° opening.
- _DE Hochschrank mit ausziehbarer bügelbrett und 270 ° öffnender tür.
- _FR Colonne avec planche a repasser extractible et porte ouverture 270°.
- _ES Columna con tabla de planchar extraíble y puerta apertura 270°.



**COLONNA
PORTA SCARPE
ANTA RIBALTA**

- _EN Shoe tall unit with flap door.
- _DE Schuhschrank mit klapptür.
- _FR Colonne porte chaussures porte abattant.
- _ES Columna porta zapatos con puerta abatible.



**COLONNA ATTREZZATA
CON DOPPIO CESTO,
CASSETTO E ANTA
A RIBALTA**

- _EN Equipped tall unit w/double basket, drawer and flap door.
- _DE Hochschrank mit doppelkorb, schublade und klappentür.
- _FR Colonne equipee avec double panier, tiroir et porte abattant.
- _ES Columna con doble cesta, cajón y puerta abatible.



**COLONNA CON
CESTI ESTRAIBILI E
PORTABIANCHERIA**

- _EN Tall unit with extractable baskets and laundry one.
- _DE Hochschrank Mit Ausziehbaren Körben Und Waschkorb.
- _FR Colonne avec paniers extractibles et panier a linge.
- _ES Columna con cestas extraíbles y compart.para ropa.



CESTI ESTRAIBILI IN ABS

- _EN Extractable ABS baskets.
- _DE Ausziehbare Kasten in ABS.
- _FR Panier extractible en ABS.
- _ES Cestas extraíbles en ABS.



COLONNA PORTASCARPE E STIVALI

- _EN Tall unit for shoes and boots.
- _DE Hochschrank für Schuhe und Stiefel.
- _FR Étagère à chaussures et bottes.
- _ES Columna para zapatos y botas.



PATTUMIERA ESTRAIBILE PER DIFFERENZIATA

- _EN Extractable dustbin for differentiated collection.
- _DE Ausziehbarer Abfalleimer für differenzierte Sammlung.
- _FR Poubelle extractible en compartiment.
- _ES Basurera extraíble para diferenciada.



IGIENIZZATORE PER IL TRATTAMENTO DELL'ARIA ALL'INTERNO DI VANI CHIUSI

- _EN Air freshener device for closed compartments.
- _DE Vorrichtung zur Luftaufbereitung in geschlossenen.
- _FR Dispositif pour le traitement de l'air à l'intérieur de compartiments fermés.
- _ES Dispositivo para el tratamiento del aire en el interior de compartimentos cerrados.

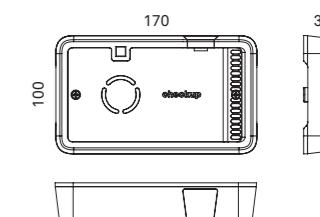



ACQUA e SAPONE

design **Monica Graffeo**

UN PROGETTO DI DESIGN CALIBRATO SULL'EVOLUZIONE DELLE ABITUDINI CONTEMPORANEE. UN AMBIENTE LAVANDERIA INFORMALE E DISCRETO MA CON UN SUO CARATTERE, GRAZIE AGLI SCANZONATI ACCESSORI.

_EN A design project based on the evolution of contemporary habits. A laundry area that is informal and discreet, yet with its own character, thanks to its genial accessories.

_DE Ein Design-Projekt, das basierend auf der Entwicklung der heutigen Gewohnheiten ausgelegt wurde. Ein informeller und diskreter Waschmaschinenbereich, der jedoch dank der auflockernden Zubehörteile einen eigenen Charakter bekommt.

_FR Un projet de conception calibré sur l'évolution des habitudes contemporaines. Une buanderie informelle et discrète mais avec un caractère propre, grâce à des accessoires non conventionnels.

_ES Un proyecto de diseño realizado según la evolución de las costumbres actuales. Un ambiente lavandería informal y discreto pero con un carácter suyo, gracias a sus accesorios alegres.

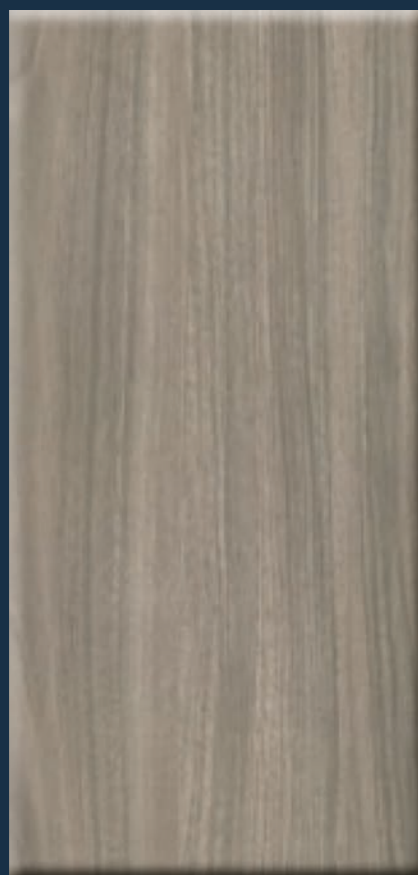

_Olmo grey 039

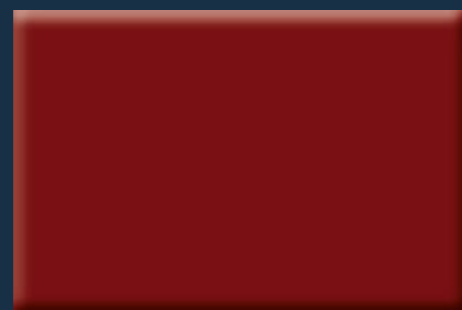

_Laccato opaco Rosso 3003

Funzionalità dall'assoluta linearità.

_EN Functionality and absolute linearity.

_DE Funktionalität von absoluter Linearität.

_FR Fonctionnalité avec une linéarité absolue.

_ES Funcionalidad con linealidad absoluta.



ANTE RIENTRANTI

- _EN Hideaway doors.
- _DE Nach innen öffnende Tür.
- _FR Portes rentrantes.
- _ES Puertas entrantes.



COMP. 1 L.90+80 P.70 H.200



_IT Le ante una volta aperte rientrano nel mobile eliminando gli ingombri frontali e facilitando le operazioni di carico scarico della lavatrice.

_EN Once the doors are open they recede into the unit, eliminating frontal encumbrances and aiding loading/unloading of the washing machine.

_DE Die Türen bewegen sich beim Öffnen nach innen, so dass vorn kein Platzbedarf entsteht und erleichtern das Be- und Entladen der Waschmaschine.

_FR Les portes rentrent dans le meuble une fois ouvertes, ceci permet d'éliminer les encombrements frontaux et de faciliter les opérations de chargement/déchargement de la machine à laver.

_ES Las puertas una vez abiertas vuelven a entrar en el mueble eliminando posibles estorbos frontales y facilitando las operaciones de carga/descarga de la lavadora.



_Olmo white 038

Volumi e venature trasformano piccoli spazi.

_EN Volumes and grain transform small spaces.

_DE Volumen und Schatten verwandeln kleine Räume.

_FR Les volumes et veinures transforment les petits espace.

_ES Volúmenes y matices transforman pequeños espacios.

PENSILE/STENDINO/CONTENITORE IN FILO VERNICIATO A POLVERI EPOSSIDICHE

_EN Wall unit/ clothes rack / wire unit coated by epoxy powder.

_DE Hängeschrank / Trockengestell/ Schrank aus gestrichenem Pulver lackiert.

_FR Élément haut/ élément pour étirer/ élément en fil vernie à poudre époxy.

_ES Colgante/tendedero/colgante barnizada en polvos epoxidicos.



PIANO CON LAVATOIO INTEGRATO IN MARMO MINERALE

_EN Top with integrated wash basin Mineral marble.

_DE Platte mit integriertem Waschbecken aus Mineral Marmor.

_FR Plan avec lavabo intégré en Marble Mineral.

_ES Encimera con lavadero integrado de Marmol mineral.





**PIANO CON LAVATOIO INTEGRATO
IN MARMO MINERALE SPESSORE
RIDOTTO DA 15 MM**

- _EN Top with integrated wash basin in Bianco gloss Mineral marble, 15 mm reduced thickness.
- _DE Arbeitsfläche mit integriertem Waschtisch aus glänzend weißem Mineral Marmor mit reduzierter Stärke von nur 15 mm.
- _FR Plan avec lavabo intégré en Marble Mineral Blanc brillant, avec épaisseur réduite à 15 mm.
- _ES Encimera con lavadero integrado de Marmol mineral Blanco brillante, con espesor reducido a 15 mm.

**PENSILE IN FILO UTILIZZABILE ANCHE
COME MINI STENDI BIANCHERIA**

- _EN In line wall unit that can also be used as a laundry rack
- _DE Drahtgestell, das auch als Mini-Wäschegestell verwendet werden kann.
- _FR Meuble haut encastré, également utilisable comme mini-étendoir
- _ES Colgante de hilo utilizable incluso como mini tendedero



_IT Basi Olmo Corda, pensili filo verniciato Bianco piano con lavatoio integrato in Pietralux Bianco lucido, disponibile anche su misura.

_EN "Olmo Corda" Bases – In line wall unit lacquered Bianco top with integrated wash basin in Bianco gloss Pietralux, also made to measure.

_DE Unterschränke Olmo Corda – Drahtgestelle weiß lackiert Arbeitsfläche mit integriertem Waschtisch aus glänzend weißem Pietralux, auch maßgefertigt erhältlich.

_FR Meubles bas Olmo Corda – Meubles hauts encastrés Blanc Plan avec lavabo intégré en Pietralux Blanc brillant, également disponible sur mesure.

_ES Bases Olmo Corda – Colgantes de hilo pintado Blanco encimera con lavadero integrado de Pietralux Blanco brillante, disponible incluso a medida.

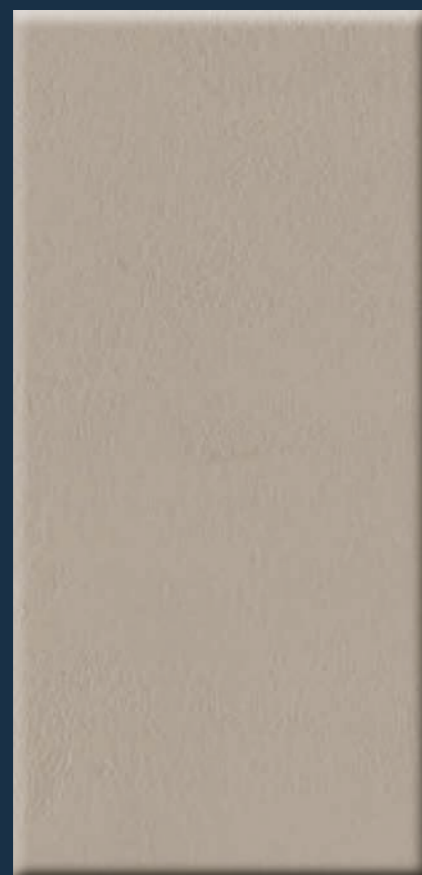

_Malta tortora 016

**Massima
versatilità
per le tue
esigenze.**

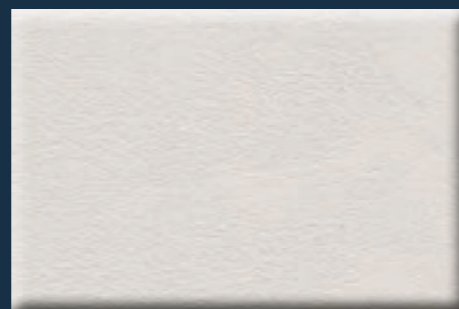

_Malta ghiaccio 015

_EN Maximum versatility for your requirements.

_DE Maximale Vielseitigkeit für deine Bedürfnisse.

_FR Polyvalence maximale pour vos besoins.

_ES Máxima versatilidad para tus necesidades.



**PANCA E MENSOLA IN MALTA TORTORA
BIANCO, LAVATOIO IN CERAMICA**

_EN Bench top and shelf in "Malta tortora Bianco" and ceramic wash basin.

_DE Bank und Ablage in Malta tortora Bianco, Keramikwaschtisch.

_FR Banc et étagère en Malta tortora Bianco, lavabo en céramique.

_ES Banco y repisa de Malta tortora Bianco, lavadero de cerámica.



**COLONNE CON ANTE
RIENTRANTI**

- _EN Vertical unit with receding doors.
- _DE Hochschränke mit nach innen öffnenden Türen.
- _FR Colonnes avec portes rentrantes.
- _ES Columnas con puertas entrantes.



COMP. 3 L.212,5 P.50/70 H.200

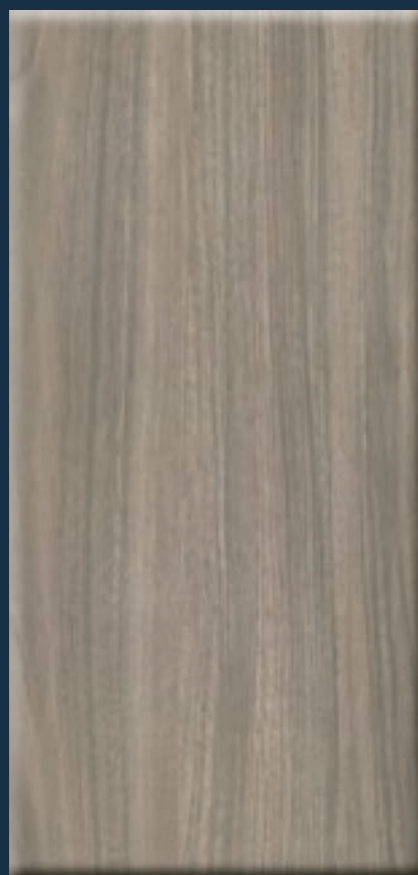

_Olmo grey 039

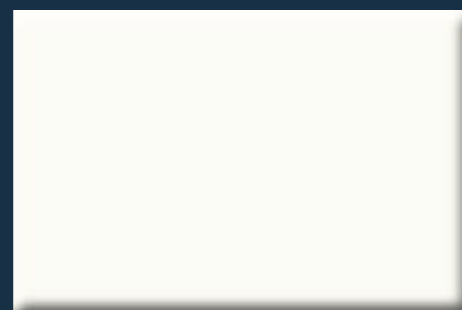

_Laccato opaco Bianco 9003

**Forme
compatte;
caratteristiche
funzionali.**

_EN Compact shapes; functional characteristics.

_DE Kompakte Formen; funktionelle Eigenschaften.

_FR Formes compactes; caractéristiques fonctionnelles.

_ES Rformas compactas; Características funcionales.





COMP. 4 L.160 P.70 H.92

PANCA LAVATOIO

_EN Washbasin bench.
 _DE Bank waschtrog.
 _FR Banquette buanderie.
 _ES Banqueta lavadero.

L. 90/120 cm
 P. 50 cm
 H. 56 cm

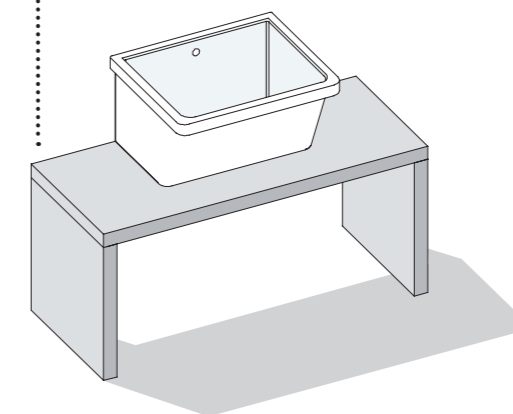

_IT Panca lavabo a ponte disponibile in essenza e laccato. Consolle lavabo 4 gambe solo in laccato.
 _EN Bench available in wooden and lacquered finishes. Bench with 4 legs available in lacquered only.
 _DE Bank Holzaustrführung oder lackiert. Bank mit 4 FüÙe nur lackiert.
 _FR banquette disponible en bois et en laqué. Banquette avec 4 pieds disponible que en laqué.
 _ES Banca disponible en madera esencia o lacada. Banca con 4 patas solo lacada.

CONSOLLE LAVATOIO

_EN Wahsbasin consolle.
 _DE Konsolle Waschtrog.
 _FR Consolle buandrie.
 _ES consola lavadero.

L. 90 cm
 P. 45 cm
 H. 56 cm

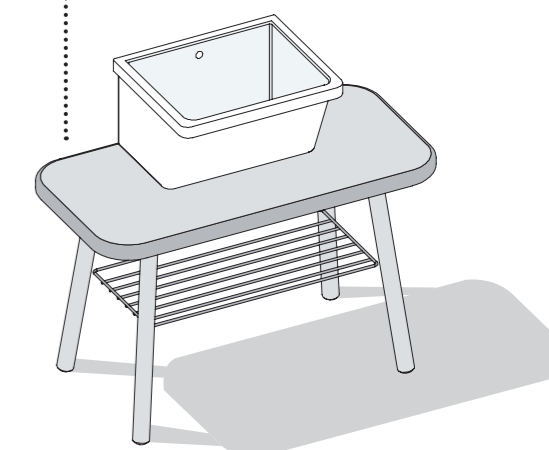

**Soluzioni
intelligenti
in piccole
dimensioni.**

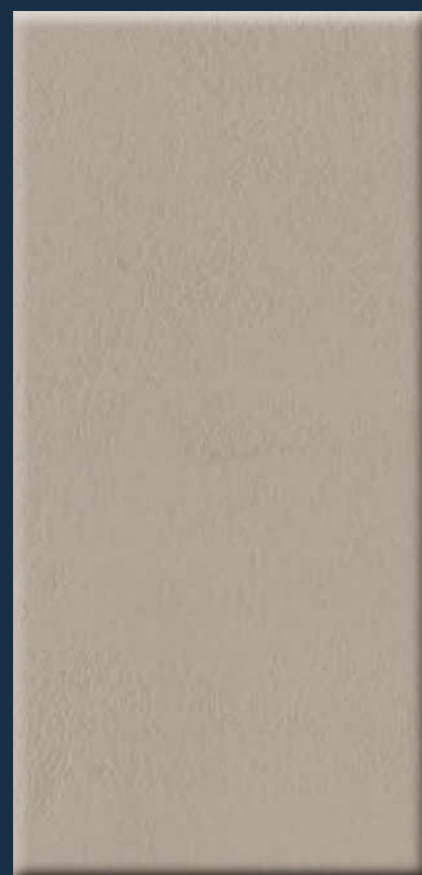

_Malta tortora 016

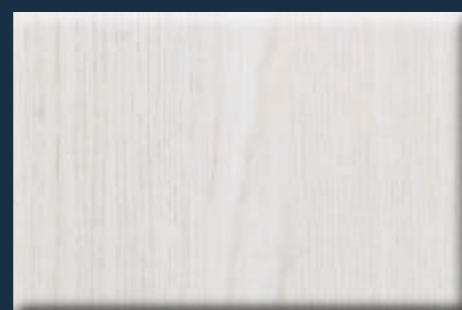

_Olmo white 038

_EN Intelligent solutions
for small dimensions.

_DE Intelligente Lösungen
in kleinen Dimensionen.

_FR Des solutions intelligentes
en petites dimensions.

_ES Soluciones inteligentes
en pequeñas dimensiones.



COMP. 5 L.120 P.50 H.93,5

SPECCHIERA/ STENDINO

_EN Mirror unit/clothes rack.
_DE Spiegelschrank/Wäscheständer.
_FR Miroir/Étendoir.
_ES Espejo /Tendedero.

L.90 P.7 H.45 cm



STENDINO A SCOMPARSA

_EN Hideaway clothes rack.
_DE Versenkbarer Wäscheständer.
_FR Étendoir rétractable.
_ES Tendedero escamoteable.

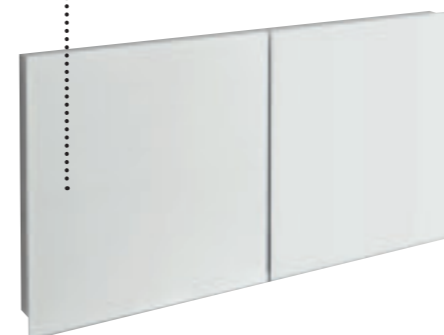

6 MT. DI FILO PER STENDERE

_EN 6 m of line for hanging.
_DE 6 m Draht zum Aufhängen.
_FR 6 m. de corde à linge.
_ES 6 metros de hilo para tender.



INNOVATIVO SPECCHIO CON STENDIBIANCHERIA APRIBILE, SGOCCIOLA DIRETTAMENTE SUL LAVABO

_EN Innovative mirror with extendible laundry rack
which drips straight into the wash basin.
_DE Innovativer Spiegel mit ausklappbarem Wäsche-
ständer, der direkt über dem Waschbecken abtropft.
_FR Miroir innovant avec étendoir ouvrable, égoutte-
ment directement au-dessus du lavabo.
_ES Espejo innovador con tendedero que se abre,
gotea directamente en el lavadero.



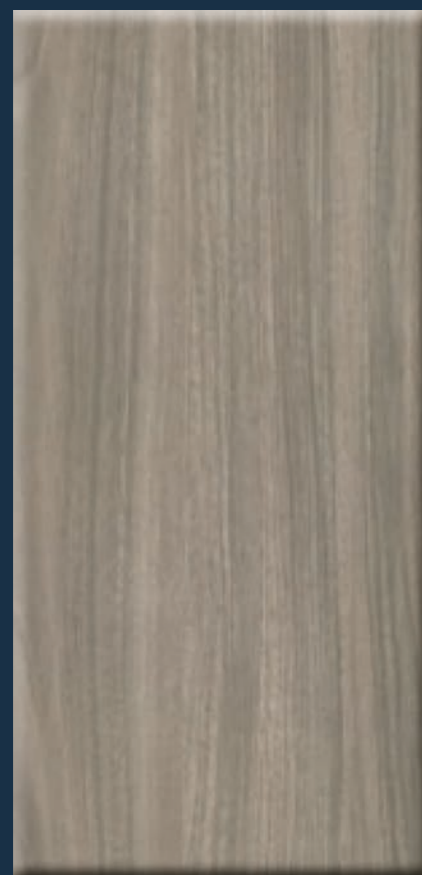

_Olmo grey 039

**Originalità
compositiva
per vestire
il tuo spazio.**

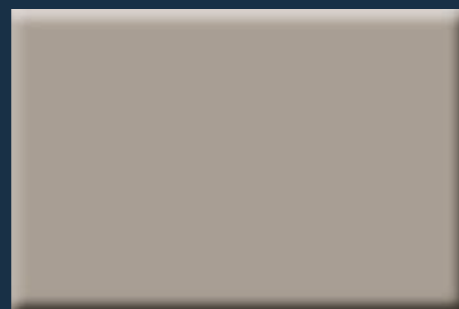

_Laccato opaco Corda Y20261

_EN Composition originality
to furnish your space.

_DE Originalität der Komposition
um Ihren Raum zu verkleiden.

_FR Originalité compositionnelle
pour habiller votre espace.

_ES Originalidad compositiva
para vestir tu espacio.



**CAPIENTE LAVATOIO
IN MARMO MINERALE**

_EN Spacious wash unit in Mineral marble.
_DE Großzügiger Waschtisch aus
Mineralischer Marmor.
_FR Grand lavabo en Marbre minéral.
_ES Lavadero grande de Mármol mineral.



COMP. 6 L.200 P.50/70 H.136

**BASE PORTALAVATRICE
SU PANCA H.44**

- EN Swashing machine base on bench h.44.
- DE Unterteil für waschmaschine auf bank h.44.
- FR Base porte machine a laver sur banquette h44.
- ES Base para lavadora sobre panca h.44.





LAVATOI

ADATTI AD UN'INSTALLAZIONE IN ESTERNO PERCHÉ RESISTENTI AGLI AGENTI ATMOSFERICI, CON VASCHE IN METACRILATO, CERAMICA O PIETRALUX. DISPONIBILI IN MOLTEPLICI MISURE E FINITURE, ANCHE CON PORTALAVATRICE INTEGRATO.

_EN Suitable for external applications as they are resistant to atmospheric agents, with methacrilate basins, ceramics or PietraLux composite available in various dimensions and finishes, also with integrated washing machine housing

_DE Geeignet für die Installation in Außenbereichen, da sie mit Becken aus Methacrylat, Keramik oder PietraLux wetterbeständig sind. Erhältlich in zahlreichen Größen und Ausführungen, auch mit integriertem Waschmaschinenschrank.

_FR Ils sont adaptés à une installation en extérieur car ils résistent aux agents atmosphériques, avec bacs en Methacrylé, céramique ou PietraLux. Disponibles dans de nombreuses tailles et finitions, également avec meuble pour machine à laver intégré.

_ES Adecuados a una instalación exterior porque resistentes a los agentes atmosféricos, con bañeras Metacrilado, cerámica o PietraLux. Disponibles en muchas medidas y acabados, incluso con espacio para la lavadora integrado.

LAVATOI/SHOE RACK

_IT Gamma di lavatoi da esterno e da interno.
_EN Range of wash basins for internal and external use.
_DE Waschtischangebot für den Innen- und Außenbereich.
_FR Gamme de lavabos d'extérieur et d'intérieur.
_ES Gama de lavaderos de exterior e interior



LAVATOIO METACRILATO STRUTTURA METALLO

_EN Wash basin in Methacrilate with metallic structure.
_DE Waschtisch Methacrylat Metallgestell.
_FR Lavabo en Methacrylé structure métallique.
_ES Lavadero Metacrilado Estructura Metal.

L.60 P. 60 H 92 cm con piedini

_EN with feet.
_DE mit Füße.
_FR avec pieds.
_ES con pata.

LAVATOIO METACRILATO

_EN Methacrilate Washbasin.
_DE Waschbecken Methacrylat.
_FR Lavabo en Methacrylé.
_ES Lavabo Metacrilado.

L. 60/75 cm
P. 60 cm
H. 92 cm



SCocca METALLICA ZINCATA VERNICIATA

_EN Galvanized and painted metallic structure.
_DE erzinkte Metallkorpus.
_FR Structure métallique zinguée et vernie.
_ES Estructura en chapa cincada.

LAVATOIO METACRILATO

_EN Methacrilate Washbasin.
_DE Waschbecken Methacrylat.
_FR Lavabo en Methacrylé.
_ES Lavabo Metacrilado.

L. 45/60/75 cm
P. 50/60 cm
H. 92 cm con piedini (feet, Füße, pieds, pata)



LAVATOIO MARMO MINERALE

_EN Mineral marble washbasin.
_DE Waschtrog in marmo minerale.
_FR Lavabo en marbre mineral.
_ES Mueble lavabo en marmo minerale.

L. 60 cm
P. 50/60 cm
H. 92 cm con piedini (feet, Füße, pieds, pata)



LAVATOIO CERAMICA

_EN Ceramic washbasin.
_DE Waschbeckenschrank Keramik.
_FR Lavabo en céramique.
_ES Lavabo ceramico.

L. 60/75 cm
P. 50 cm
H. 92 cm



LAVATOI/LAUNDRIES



L. 110 cm



LAVATOIO METACRILATO CON PORTALAVATRICE

_EN Methacrilate Washbasin.
_DE Waschbecken Methacrylat.
_FR Lavabo en Methacrylé.
_ES Lavabo Metacrilado.

L. 110 cm
P. 60 cm
H. 92 cm con piedini (feet, Füße, pieds, pata)



LAVATOI/LAUNDRIES



L. 124 cm



LAVATOIO METACRILATO

_EN Methacrilate Washbasin.
_DE Waschbecken Methacrylat.
_FR Lavabo en Methacrylé.
_ES Lavabo Metacrilado.

L. 124 cm
P. 60 cm
H. 92 cm con piedini (feet, Füße, pieds, pata)

LAVATOI/LAUNDRIES



L. 131 cm



ANTE CON APERTURA 270°

_EN Doors w/270° opening hinges. / _DE Türen mit öffnung 270°.
_FR Porte avec ouverture a 270°. / _ES Puertas con apertura 270°.

LAVATOIO METACRILATO CON PORTALAVATRICE

_EN Methacrylate washbasin with washing machine unit.
_DE Waschtrog methacrylat mit waschmaschinenteil.
_FR Lavabo en méthacrylate avec porte machine a laver.
_ES Mueble lavado metacrilado con portalavadora.

L. 135 cm
P. 65 cm
H. 92 cm con piedini (feet, Füße, pieds, pata)

ACCESSORI LAVATOI/LAUNDRIES



SERRATURA SICUREZZA BAMBINI

_EN Children safety lock.
_DE Sicherheitsverschluss für kinder.
_FR Serrure de securite pour enfants.
_ES Cerradura de seguridad para niños.



CESTO ESTRAIBILE

_EN Extractable basket
_DE Ausziehbarer korb
_FR Panier extractible
_ES Cesta extraíble



PORTA DETERSIVI

_EN Detergents holder.
_DE Waschmittelhalter.
_FR Porte-détergent.
_ES Portadetergente.



PATTUMIERA

_EN Dustbin
_DE Mülltonne
_FR Poubelle
_ES Portabasura



CONTENITORI

/CONTAINERS

AVETE MAI PENSATO A QUANTI OGGETTI DIVERSI UTILIZZIAMO OGNI GIORNO? UN NUMERO QUASI INFINITO, OGNUNO CON LE SUE CARATTERISTICHE, LE SUE FUNZIONI ED I SUOI VALORI. E' BELLO SAPERE CHE OGNUNO DI QUESTI OGGETTI PUO' TROVARE IL GIUSTO SPAZIO NELLA NOSTRA CASA. ED E' ANCORA PIU' BELLO SAPERE CHE SARA' FACILE E COMODO TROVARLI, UTILIZZARLI E RIPORLI.

_EN Have you ever wondered how many different objects we use on a daily basis? They are almost countless in number, each with its own properties, functions and worth. It's nice to know that every one of these objects can have a dedicated place in our home. And it's even nicer to know that they are easy to find, use and put away.

_DE Eine fast unendliche Anzahl, jeder mit seinen Eigenschaften, Funktionen und seinem Nutzen. Es ist schön zu wissen, dass jeder dieser Gegenstände in unserem Heim seinen Platz finden kann. Und es ist noch besser zu wissen, dass sie einfach und bequem zu finden, zu benutzen und aufzuräumen sind.

_FR Avez-vous déjà pensé à la quantité d'objets que nous utilisons chaque jour ? Un nombre presque infini, chacun avec ses propres caractéristiques, fonctions et valeurs. Il est bon de savoir que chacun de ces objets peut trouver sa juste place dans la maison. Et c'est encore mieux de savoir qu'il sera facile et pratique de les trouver, de les utiliser et de les ranger.

_ES ¿Han pensado alguna vez acerca de cuantos objetos utilizamos cada día? Un número casi infinito; cada uno con sus características, funciones y valores. Es importante saber que cada uno de estos objetos tiene un espacio en nuestra casa. Y es aún más importante saber que será fácil y cómodo encontrarlos, utilizarlos y volverlos a dejar.



X BOX

QUESTA FAMIGLIA DI CONTENITORI APRE MOLTEPLICI POSSIBILITA' DI UTILIZZO, ANCHE IN SPAZI RISTRETTI, GRAZIE ALL'ASSENZA DI INGOMBRO FRONTALE. COMPONIBILI, SOVRAPPONIBILI, PERMETTONO DI CREARE LE PIU' DIVERSE COMPOSIZIONI. TANTISSIME LE ATTREZZATURE INTERNE, DAI SEMPLICI RIPIANI AL LETTO ESTRAIBILE.

_EN This family of containers is to open a myriad of possible uses, even in confined spaces, thanks the absence of frontal encumbrances. Modular and stackable, allowing for all manner of different compositions. Many internal arrangements, from simple shelves to fold away beds.

_DE Diese Behälterfamilie eröffnet dank des fehlenden Raumbedarfs vorn zahlreiche Einsatzmöglichkeiten auch auf engem Raum. Anbaubar und übereinanderstellbar gestatten sie die unterschiedlichsten Zusammensetzungen. Überaus zahlreich die Innengestaltung, von einfachen Böden bis zum Ausziehbett.

_FR Cette famille de rangements permet de multiples usages, également dans les espaces restreints, grâce à l'absence d'encombrement frontal. Composables, superposables, ils permettent de créer toute sorte de compositions. De nombreux équipements internes, des simples étagères au lit extractible.

_ES Esta familia de contenedores incluye muchas posibilidades de uso, incluso en espacios muy pequeños, gracias a la ausencia de estorbo frontal. Componibles, apilables, permiten crear las composiciones más diferentes. Muchas las instalaciones interiores, empezando por los mismos encimeras hasta llegar a la cama extraíble.

X BOX/CONTAINERS

- _IT Programma componibile mobili contenitori con chiusura a persiana.
- _EN Container arrangements with shutter doors, available in multiple sizes.
- _DE Programm an Behältern mit Rollladenfront in zahlreichen Größen.
- _FR Programme de rangements avec fermeture à volet disponible en plusieurs tailles.
- _ES Programa contenedores con cierre de persiana disponible en diferentes medidas.

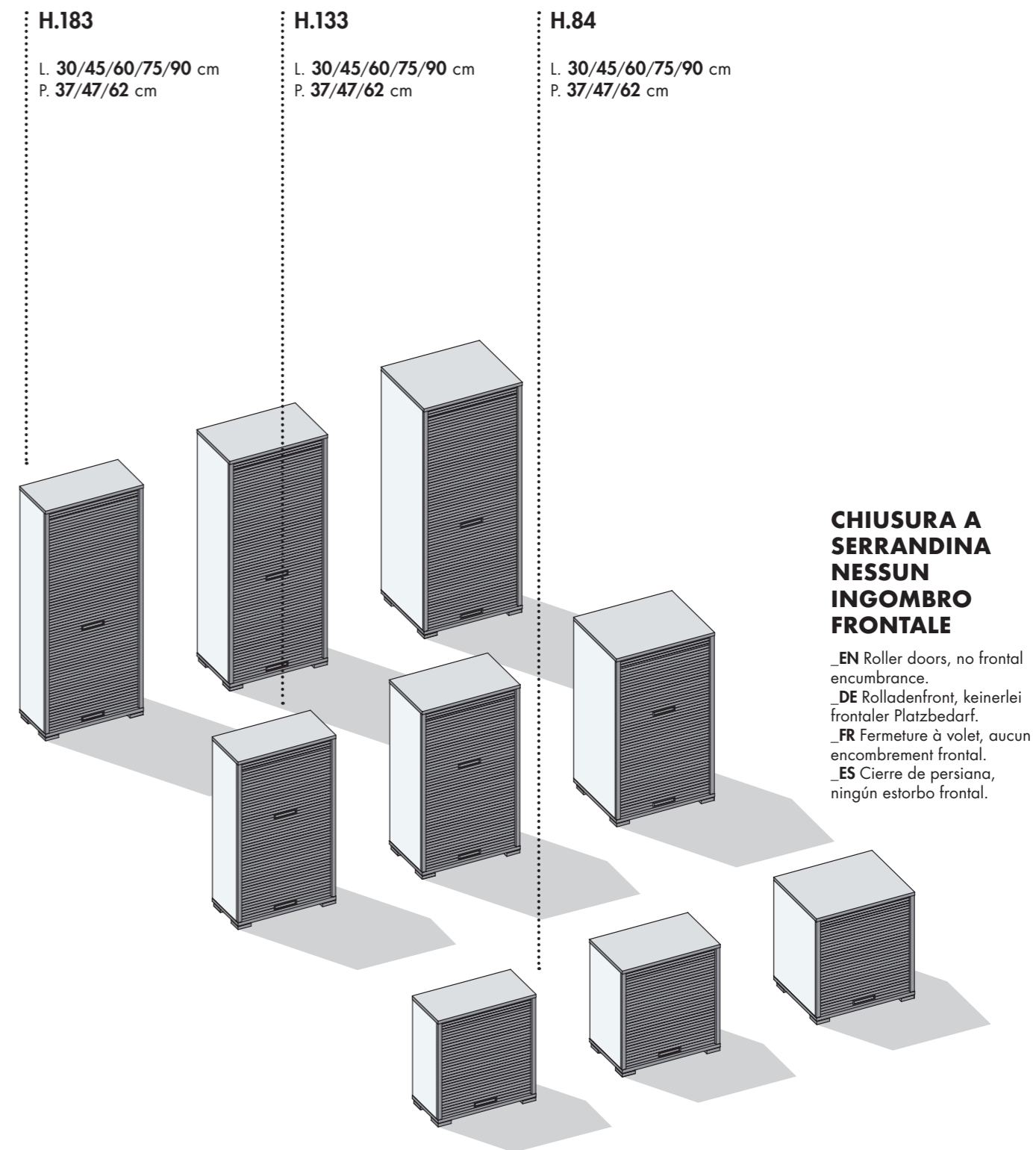

X BOX/CONTAINERS

- _EN Vertical unit "Olmo White/Grigio Garda
- _DE Hochschränke Olmo White/Grigio Garda
- _FR Colonne Olmo White/Grigio Garda
- _ES Columnas Olmo White/Grigio Garda





**GRIGLIE
PORTASCARPE**

- _EN Shoe rack.
- _DE Schuhablagegitter.
- _FR Grille porte-chaussures.
- _ES Rejilla para los Zapatos.

**APPENDIABITI
ESTRAIBILE**

- _EN Extractable clothes rack.
- _DE Ausziehbarer Kleideraufhänger.
- _FR Porte-manteau extractible.
- _ES Perchero extraíble.

**RIPIANI
SAGOMATI**

- _EN Contoured shelves.
- _DE Profilböden.
- _FR Étagères découpées.
- _ES Encimeras perfilados.

**TUBO
APPENDIABITI
E CASSETTI**

- _EN Clothes rack and drawers.
- _DE Kleiderstange und Schubladen.
- _FR Tringle et tiroirs.
- _ES Tubo perchero y cajones.

LETTO

- _EN Bed.
- _DE Bett.
- _FR Lit.
- _ES Cama.

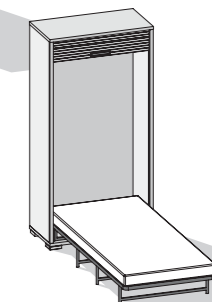
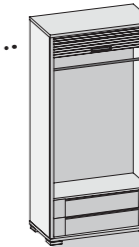
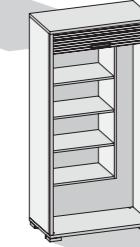
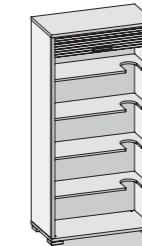
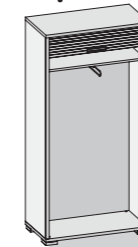
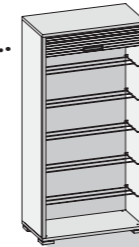

RIPIANI

- _EN Shelves.
- _DE Böden.
- _FR Étagères.
- _ES Encimeras.

PORTASCOPE

- _EN Broom cabinet.
- _DE Besenhalter.
- _FR Porte-balais.
- _ES Portaescobas.

X BOX/CONTAINERS

_IN Dettaglio dello scorrimento silenzioso su ruote con guarnizioni in gomma.
_EN Einzelansicht des leisen Gleitens auf Rädern mit Gummidichtungen.
_DE Special silent sliding action on wheels with rubber seals.
_FR Détail de coulissement silencieux sur roulettes avec joints en caoutchouc
_ES Detalle desplazamiento silencioso sobre ruedas con juntas de goma.



_IN Schiena rinforzata, spessore 10 mm.
_EN Reinforced back, thickness 10.
_DE Verstärktes Rückteil Stärke 10
_FR Dos renforcé épaisseur 10.
_ES Respaldo reforzado espesor 10.

_IN Rallentatore di corsa con molle in acciaio.
_EN Runner dampening with with steel springs.
_DE Verlangsamer mit Stahlfedern.
_FR Ralentisseur de course avec ressorts en acier.
_ES Moderador de recorrido con resortes de acero.

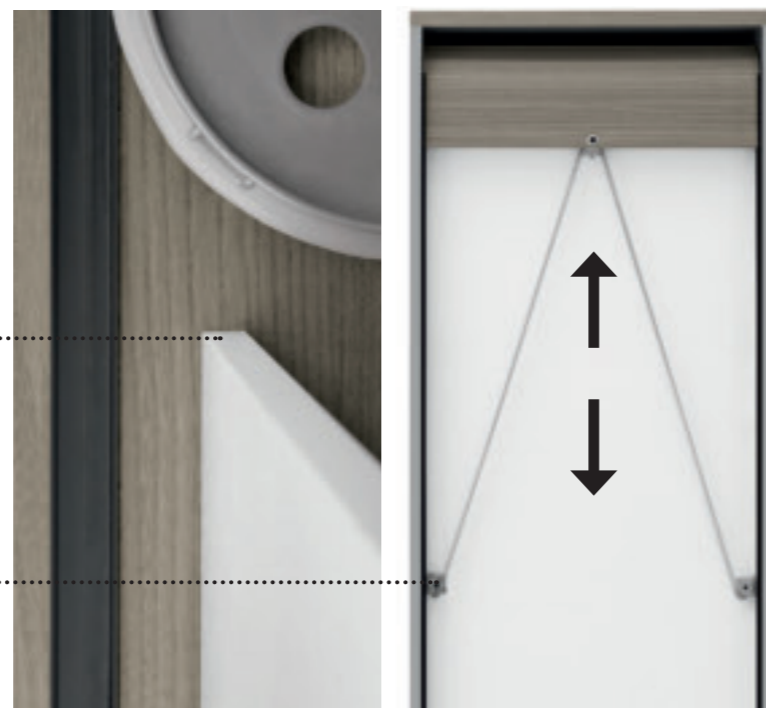

_IN Persiana rivestita in film.
_EN Shutter covered in film.
_DE Mit Folie verkleideter Rollladen.
_FR Persienne revêtue avec film.
_ES Persiana revestida de película.



_IN Battuta persiana in estruso morbido.
_EN Shutter stopper in soft extrusion.
_DE Rollladenanschlag aus weichem Extrusionsmaterial.
_FR Butée persienne en matériau extrudé mou.
_ES Tope persiana de extruido suave.

_IN Piede con regolazione dall'interno.
_EN Feet adjustable from the inside.
_DE Von innen verstellbarer Fuß.
_FR Pie con ajuste desde el interior.
_ES Pied avec réglage interne



**LETTO ESTRAIBILE
NELLA PROFONDITÀ
47 CM**

EN Fold away bed at depth of 47 cm.
DE Ausziehbares Bett in der Tiefe 47 cm.
FR Lit extractible profondeurs 47 cm.
ES Cama extraíble de profundidad 47 cm.

EN Vertical unit "Olmo White
DE Hochschränke Olmo White
FR Colonne Olmo White
ES Columnas Olmo White



**COLONNA CON
LETTO ESTRAIBILE**
(materasso incluso)

- _EN Vertical fold away bed unit
(mattress included).
- _DE Hochschrank mit Ausziehbett
(einschließlich Matratze).
- _FR Colonne avec lit extractible
(matelas inclus).
- _ES Columna con cama extraíble
(colchón incluido).



X BOX/CONTAINERS

Colonne con sopralzo Bianco 050 L.225+225 P.60 H.263

_EN Vertical unit with riser Bianco 050.

_DE Hochschrank mit Aufsatz Bianco 050.

_FR Colonnes avec surélévation Bianco 050.

_ES Columnas con terraplén Bianco 050.





BRACCIO DI FERRO

FORTI, VERSATILI, RESISTENTI ALLE INTEMPERIE, QUESTI CONTENITORI METALLICI SONO ADATTI A TERRAZZI, VERANDE E BALCONI. DISPONIBILI CON ANTE BATTENTI O CON CHIUSURA A PERSIANA, POSSONO ESSERE ABBINATI AI LAVATOI DA ESTERNO.

_EN Strong, versatile and weather-resistant, these metal containers are suitable for terraces, porches and balconies. Available with hinged doors or with sliding shutters, can be combined with outdoor wash basins.

_DE Diese strapazierfähigen, vielseitigen und wetterfesten Metallschränke sind für Terrassen, Veranden und Balkons geeignet. Erhältlich mit Flügeltüren oder mit Rollläden und mit Außenwaschtischen kombinierbar.

_FR Forts, versatiles, résistants aux intempéries, ces rangements métalliques sont adaptés aux terrasses, vérandas et balcons. Disponibles avec portes battantes ou fermeture en persienne, ils peuvent être associés à des lavabos d'extérieur.

_ES Fuertes, versátiles, resistentes a la intemperie, esto contenedores de metal son ideales para terrazas, verandas o balcones. Disponible con puertas batientes o con cierre de persiana, pueden combinarse con lavaderos de exterior.

BRACCIO DI FERRO/CONTAINERS

_IT Colonna L.75 P.40 H.182
Bianco ghiaccio.
Base portalavatrice L.60 P.60
H.92 Bianco ghiaccio.

_EN Vertical unit W.75 D.40
H.182 Bianco Ghiaccio.
Washing machine housing
base W.60 D.60 H.92 Bianco
Ghiaccio.

_DE Hochschrank L 75 T 40 H
182 Eisweiß
Waschmaschinenunterschrank
L. 60 T. 60 H. 92 Eisweiß

_FR Colonne L.75 P.40 H.182
Blanc Glaçon.
Meuble bas meuble machine
à laver L.60 P.60 H.92 Blanc
Glaçon.

_ES Columna L75 P40 H182
Blanco Hielo.
Base portalavadora L.60 P.60
H92 Blanco Hielo.



_IT Programma mobili contenitori da esterno garantito contro gli agenti atmosferici.
_EN Container furniture arrangements for outdoors, guaranteed to resist atmospheric agents.
_DE Programm an garantiert wetterfesten Schränken für den Außenbereich.
_FR Programme de meubles de rangement d'extérieur garantis contre les agents atmosphériques.
_ES Programa muebles contenedores para el exterior asegurado contra agentes atmosféricos

COLONNE

_EN Vertical units.
_DE Hochschränke.
_FR Colonnes.
_ES Columnas.

L. 60/75/90 cm
P. 40 cm
H. 182 cm

BASI

_EN Bases.
_DE Unterschränke.
_FR Meubles bas.
_ES Bases.

L. 60/75/90 cm
P. 60/70 cm
H. 92 cm

COPRILAVATRICE

_EN Washing machine housing.
_DE Waschmaschinenschränke.
_FR Cache-machine à laver.
_ES Cubrelavadora.

L. 75 cm
P. 60/70 cm
H. 92 cm

LAVATOI

_EN Wash basins.
_DE Waschtische.
_FR Lavabos.
_ES Lavaderos.

L. 60/75 cm
P. 60 cm
H. 93,5 cm

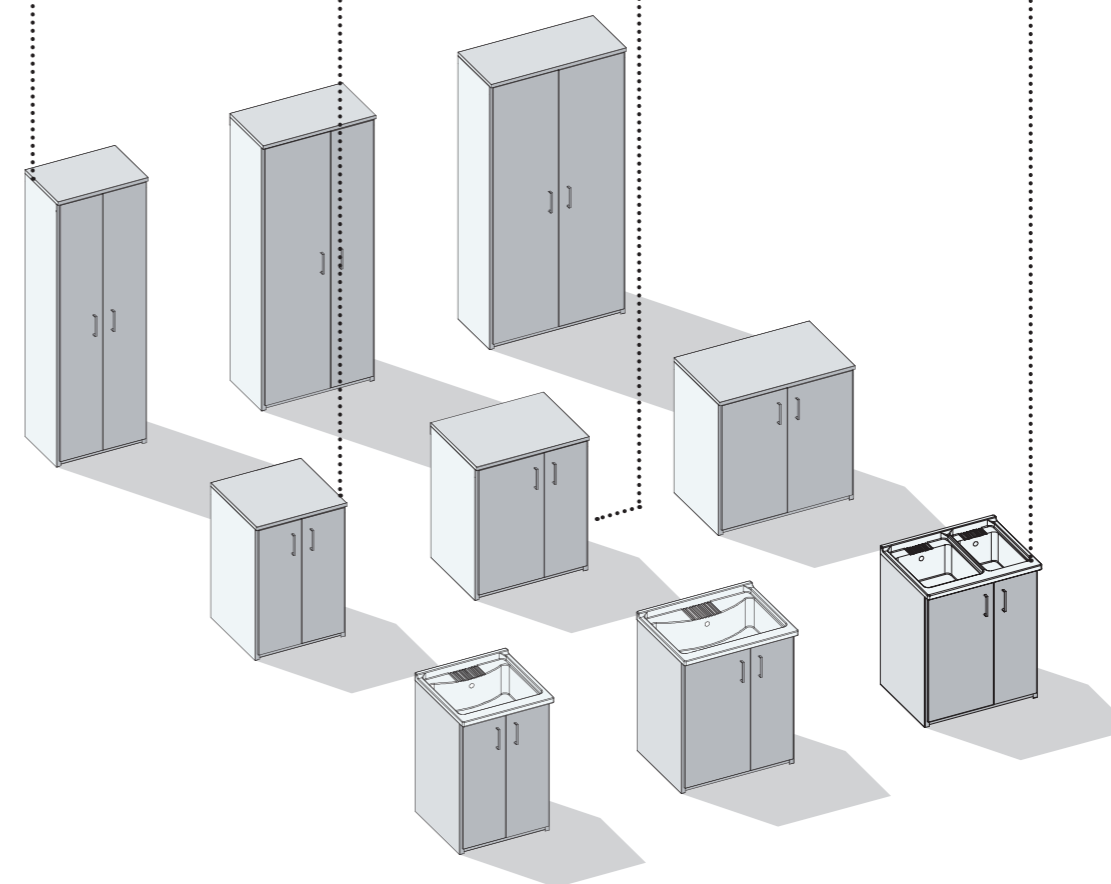

STRUTTURA METALLICA ZINCATA E VERNICIATA A POLVERI

_EN Zinc-plated and powder-coated metal structure.
_DE Verzinkte und mit Pulver lackierte Metallstruktur.
_FR Structure métallique galvanisée et peinte par poudrage.
_ES Estructura metálica cincada y pintada con polvos.

COLONNA PORTASCOPE

- _EN Broom cabinet wall unit.
- _DE Besenhalter-Hochschrank.
- _FR Colonne équipée porte-balais.
- _ES Columna portaescobas.



BASE COPRILAVATRICE P. 60/70

- _EN Washing machine housing base 60/70.
- _DE Waschmaschinenunterschrank 60/70.
- _FR Meuble bas cache-machine à laver 60/70.
- _ES Base cubrelavadora 60/70.



SERRATURA

(optional)

- _EN Lock (optional).
- _DE Schloss (Option).
- _FR Serrure (en option).
- _ES Cerradura (opcional).



PATTUMIERA PER RACCOLTA DIFFERENZIATA

(optional)

- _EN Recycling bin (optional).
- _DE Abfalleimer für Mülltrennung (Option).
- _FR Poubelle pour tri sélectif (en option).
- _ES Cubo de la basura para recogida separada (opcional).



BRACCIO DI FERRO/CONTAINERS

_IT Lavatoio L.60 P.60 H.92
Bianco ghiaccio.
Base portalavatrice L.60 P.60
H.92 Bianco ghiaccio.

_EN Wash basin W.60 D.60
H.92 Bianco Ghiaccio.
Washing machine housing
base W.60 D.60 H.92 Bianco
Ghiaccio.

_DE Waschtisch L60 T 60 H
92 Eisweiß.
Waschmaschinenunterschrank
L 60 T 60 H 92 Bianco
Ghiaccio.

_FR Lavabo l.60 p.60 h.92
Blanc Glaçon.
Meuble bas pour machine à
laver L.60 P.60 H.92 Bianco
Ghiaccio.

_ES Lavadero l60p60h92
Blanco hielo.
Base portalavadora L.60 P.60
H92 Bianco Ghiaccio.

_IT Lavatoio in Metacrilato.
_EN Wash basin in Methacrylate.
_DE Waschtisch aus Methacrylat.
_FR Lavabos en Methacrylé.
_ES Lavadero de Metacrilado.



BRACCIO DI FERRO/CONTAINERS

L.210 P.40 H.182 Colonne Bianco ghiaccio

- _EN Vertical unit Bianco Ghiaccio
- _DE Hochschränke Bianco Ghiaccio
- _FR Colonnes Bianco Ghiaccio
- _ES Columnas Bianco Ghiaccio



- _IN Struttura ed ante in lamiera zincata e verniciata a polveri epossidiche.
- _EN Structure and doors in zinc-plated steel and powder coated in epoxy.
- _DE Struktur und Türen aus verzinktem und mit Epoxidpulver lackiertem Blech.
- _FR Structure et portes en tôle galvanisée et peintes avec poudre époxy.
- _ES Estructura y puertas de chapa cincada y pintada con polvos epoxi.



- _IN Piedino regolabile.
- _EN Adjustable feet.
- _DE Höhenverstellbarer Fuß.
- _FR Pied réglable.
- _ES Pata regulable.



- _IN Rallentatore di corsa con molla in acciaio.
- _EN Runner dampening with with steel springs.
- _DE Verlangsamer mit Stahlfeder.
- _FR Ralentisseur de course avec ressort en acier.
- _ES Moderador de recorrido con resortes de acero.



- _IN Persiana rivestita in film.
- _EN Shutter covered in film.
- _DE Mit Folie verkleideter Rollladen.
- _FR Persienne revêtue avec film.
- _ES Persiana revestida de película.



BRACCIO DI FERRO/CONTAINERS

L.60/90 P.40 H.182 Colonne Bianco Ghiaccio

_EN Wall unit Bianco Ghiaccio.

_DE Rollladen-Hochschrank Bianco Ghiaccio.

_FR Colonnes à volet Bianco Ghiaccio.

_ES Columnas de persiana Bianco Ghiaccio.



BRACCIO DI FERRO/CONTAINERS

L. 60

P. 40 cm
H. 183/84 cm

L. 75

P. 40 cm
H. 183/84 cm

L. 90

P. 40 cm
H. 183/84 cm

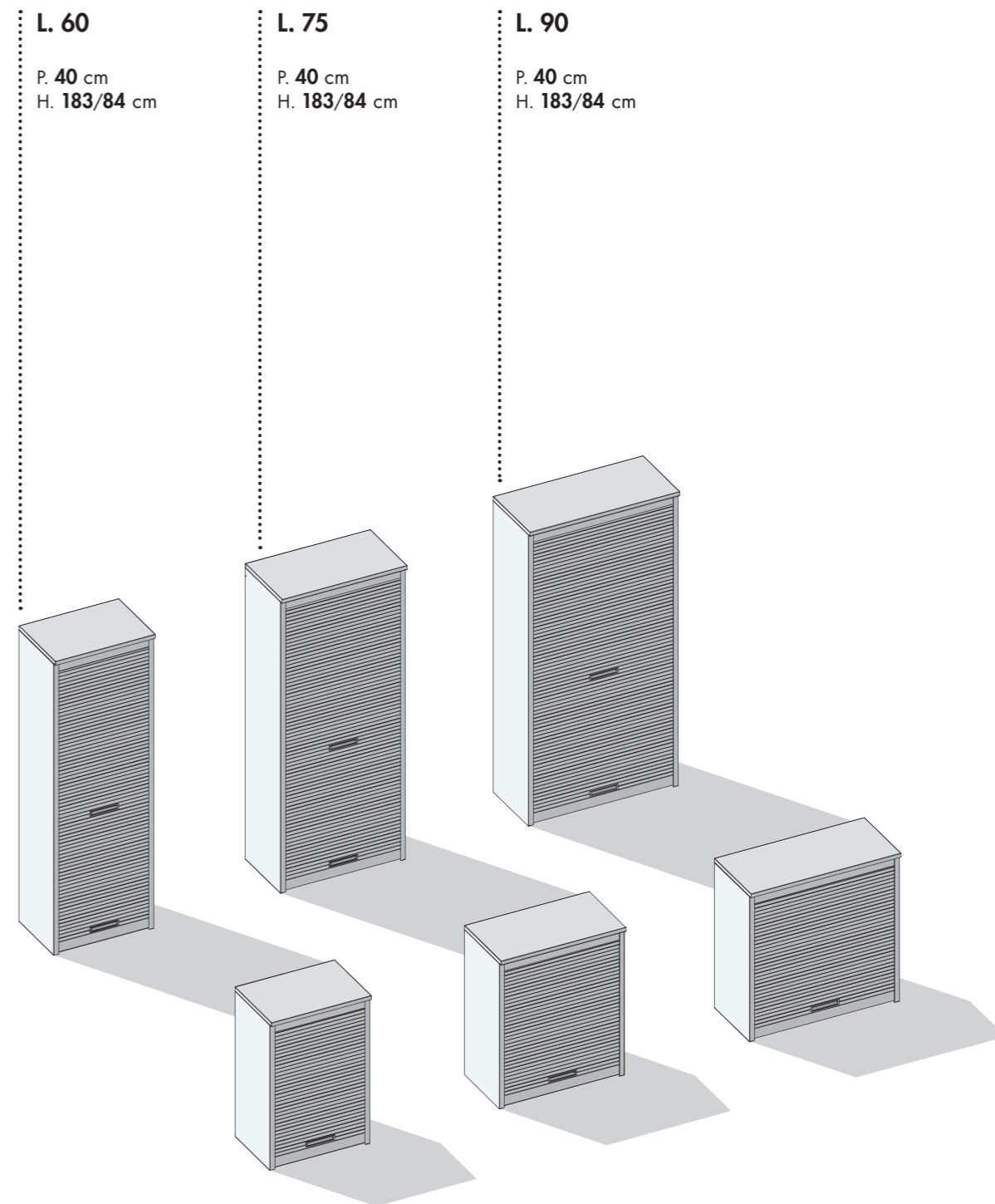



PIANI INTEGRATI/LAVATOI

PIANI INTEGRATI IN MARMO MINERALE

Disponibili in prof. 50-60-70 cm e larghezze come da schema.

_EN Top integrated in PietraLux available in widths 50-60-70 cm and lengths as per data sheet.

_DE integrierte Flächen aus PietraLux mit Tiefe 50-60-70 cm und Breiten wie in der Tabelle angegeben.

_FR Plans intégrés en PietraLux disponibles en prof. 50-60-70 cm et largeurs comme sur schéma.

_ES Encimeras integrados de PietraLux disponibles de prof. 50-60-70 cm y anchos como se muestra en el esquema.

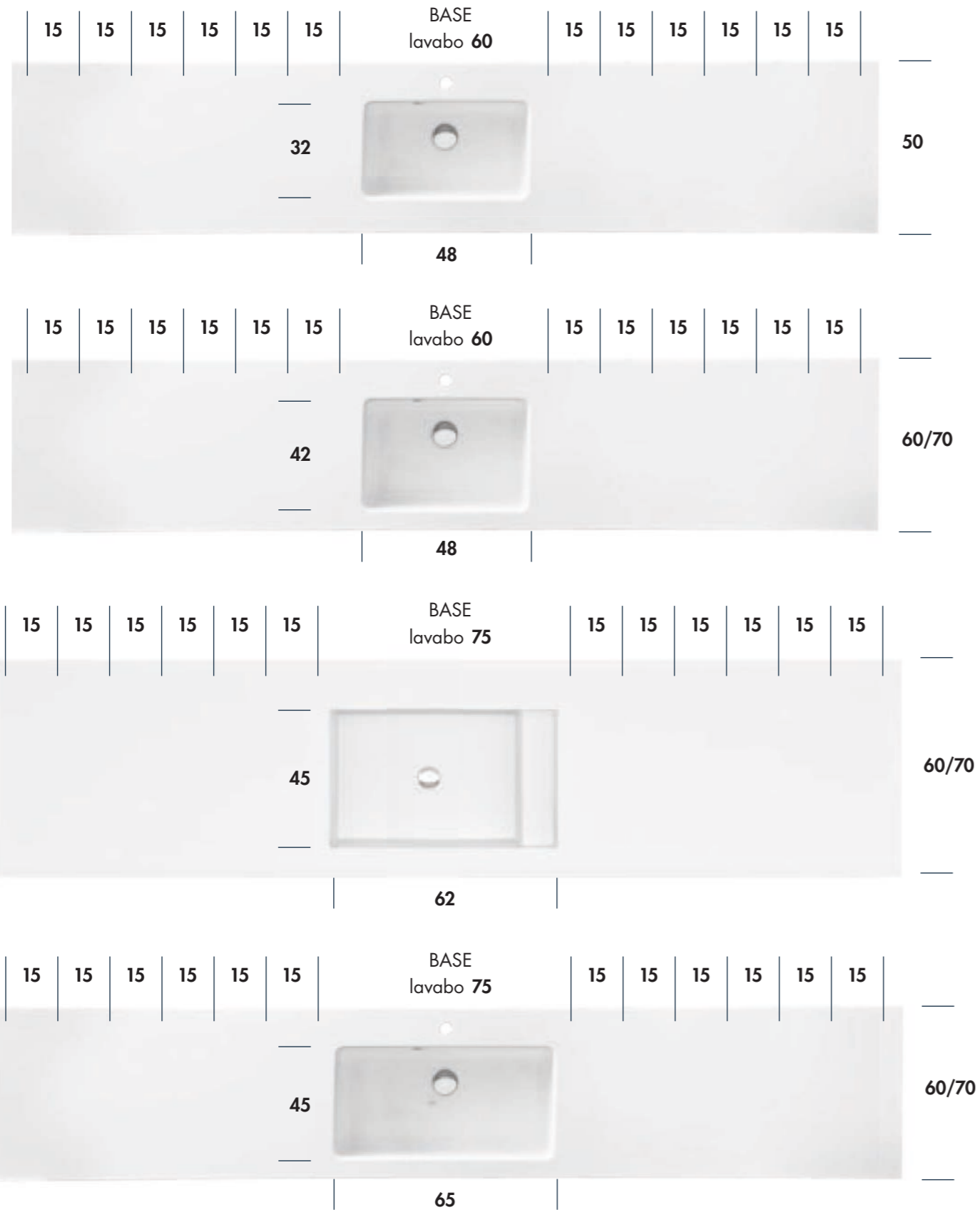

PIANI INTEGRATI IN MARMO MINERALE

Disponibili in prof. 50-60-70 cm e larghezze come da schema.

_EN Top integrated in PietraLux available in widths 50-60-70 cm and lengths as per data sheet.

_DE integrierte Flächen aus PietraLux mit Tiefe 50-60-70 cm und Breiten wie in der Tabelle angegeben.

_FR Plans intégrés en PietraLux disponibles en prof. 50-60-70 cm et largeurs comme sur schéma.

_ES Encimeras integrados de PietraLux disponibles de prof. 50-60-70 cm y anchos como se muestra en el esquema.

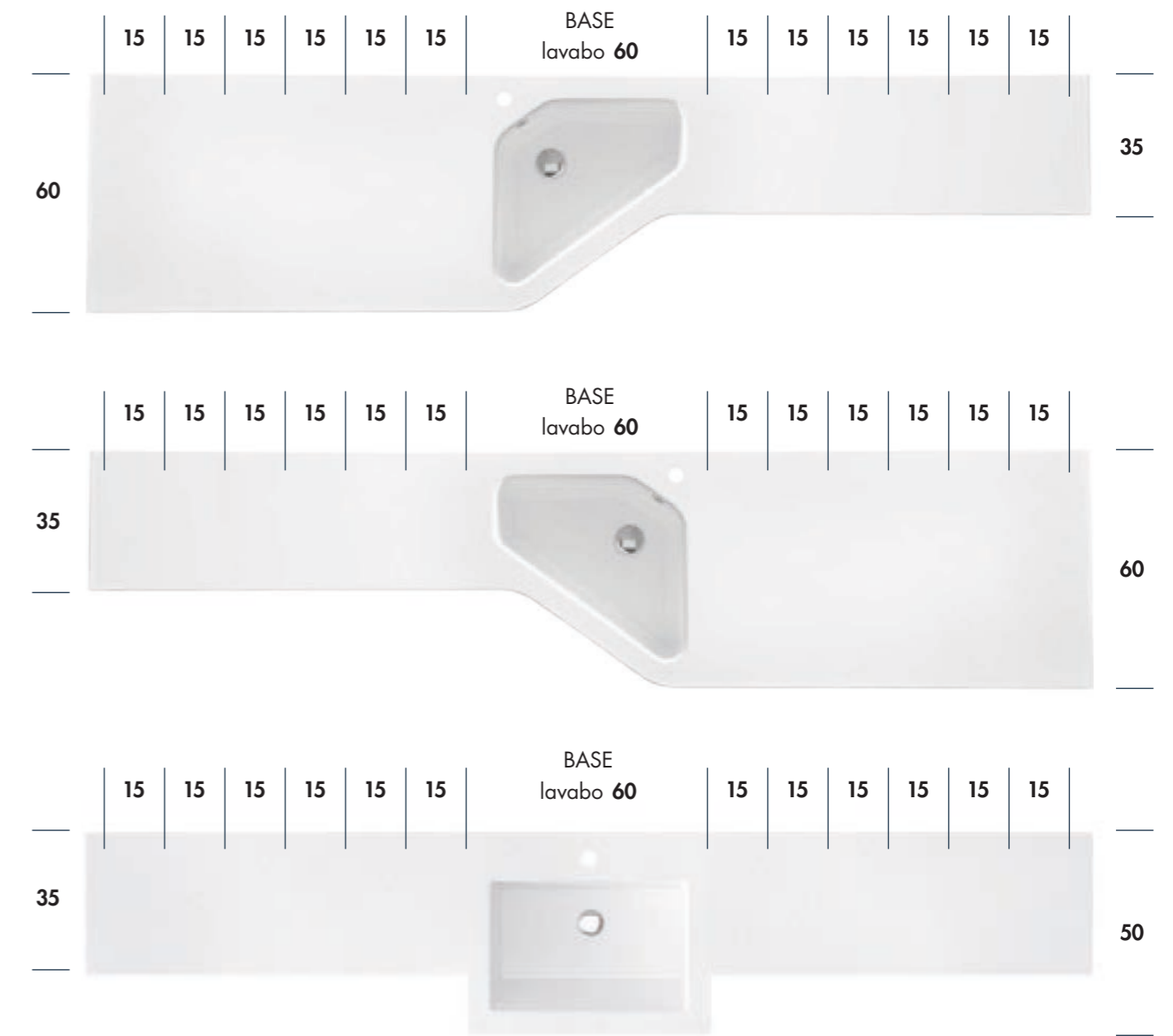

LAVATOI INCASSO SOPRAPIANO

- _EN Integrated over counter washbasin.
- _DE Eingelassene einbau-waschbecken.
- _FR Lavabo encastré sur plan.
- _ES Lavabos empotrados sobre encimeras.

LAVATOIO IN MARMO MINERALE

- L. 45/60 P. 50/60 H. 24 cm.
- _EN Mineral marble washbasin.
- _DE Waschtrog in mineralmarmo.
- _FR Lavabo marbre mineral.
- _ES Lavabo in mineralmarmo.



LAVATOIO IN METACRILATO

- L. 57 P. 36 H. 25 cm.
- _EN Methacrylate washbasin.
- _DE Waschbasin in methacrylat.
- _FR Lavabo en metachrylat.
- _ES Lavabo en metacrilado.



LAVATOIO IN CERAMICA

- L. 61/71 P. 51 H. 23 cm.
- _EN Ceramic washbasin.
- _DE Waschbecken aus keramik.
- _FR Lavabo en ceramique.
- _ES Lavabo en cerámica.



LAVATOI SOPRAPIANO IN CERAMICA

- _EN Over counter washbasin.
- _DE Aufsatz- waschtrog
- _FR Lavabo sur plan.
- _ES Lavabo sobre encimera.

LAVATOIO NINIVE INCASSO SOPRAPIANO

- L. 90 P. 45 H. 20 cm.
- _EN Over counter ninive washbasin.
- _DE Aufsatz- waschtrog ninive.
- _FR Lavabo ninive sur plan.
- _ES Lavabo sobre encimera ninive.



LAVATOIO SOPRAPIANO

- L. 60 P. 38 H. 25 cm.
- _EN Project over counter washbasin.
- _DE Aufsatz waschtrog project.
- _FR Lavabo projet sur plan.
- _ES Lavabo sobre encimera project.



LAVATOIO MEG CON FORO RUBINETTO

- L. 55 P. 48 H. 48 cm.
- _EN MEG washbasin with hole for faucet.
- _DE Waschtrog MEG- mit bohrung für armatur.
- _FR Lavabo MEG avec trous robinet.
- _ES Lavabo MEG- con hueco para grifo.



CARATTERISTICHE TECNICHE

_EN Technical features
 _DE Technische Merkmale
 _FR Caractéristiques techniques
 _ES Especificaciones técnicas



_Pannello ecologico, certificato CARB-Phase2.
 _Certified ecological panel, CARB-Phase2.
 _Ökologisch nachhaltige Platte, Zertifikat CARB-Phase2.
 _Panneau écologique certifié CARB-Phase2.
 _Panel ecológico, certificado CARB-Phase2.

_Cassettoni metallici ad estrazione totale con chiusura rallentata Blumotion.
 _Full-extraction metal deep drawer with Blumotion soft closing system.
 _Schubkasten aus Metall mit Vollauszug und gebremstem Schließmechanismus Blumotion.
 _Coulissant métallique avec extraction totale et fermeture à ralentisseur Blumotion.
 _Gaveta metálica de extracción total con cierre amortiguado Blumotion.

_Barra di rinforzo in alluminio.
 _Reinforced bar in aluminum.
 _Griffprofil aus Aluminium in gleicher Farbe lackiert.
 _Barre de renfort en aluminium.
 _Barra de refuerzo de aluminio.

_Attaccaglia alta portata con tripla regolazione e sistema antigancio.
 _High-capacity fixing, 3-way adjustment and anti-release system.
 _Träger von hoher Tragfähigkeit, mit Dreifach-Regulierung und Sperrsystem.
 _Suspension charge lourde avec triple réglage et système anti-décrochage.
 _Herraje de gran capacidad con tres regulaciones y sistema anticaída.

_Cerniera con chiusura ammortizzata integrata a scomparsa Salice.
 _Hinge Salice with integrated retractable soft closing.
 _Einziehbarer Scharnier Salice mit gedämpfter Schliessung.
 _Charnière Salice avec fermeture ralentie intégrée.
 _Bisagra con cierre amortizado mod. Salice.

_Ripiano melaminico bianco sp. 18 mm.
 _White melamine shelf th. 18 mm.
 _Boden St. 18 mm in Melamin weiss.
 _Étagère en mélamine blanche Ep. 18 mm.
 _Estante 18 mm en melamina blanca.

ACCESSORI

_EN Accessories.
_DE Zubehörteile.
_FR Accessoires.
_ES Accesorios.



_Finiture:



_Finiture:



SPECCHI CONTENITORI E FUNZIONALI

_EN Functional and storage mirrors. _DE Spiegelschränke und Funktionsspiegel.
_FR Miroirs. _ES Armarios con espejo y funcionales.

**CONTENITORE SPECCHIO
STENDINO**
L.90 P.10 H.45



ACQUA E SAPONE
L.50 P.19 H.50



SPECCHIO 45°
L.45/60/75/90/105/120
P.20 H.36/48/60



MIVEDO
L.120 P.15 H.51



FILO LUCIDO
L.60/75/90/105/120/135/1
50/165/180 P.2.5
H.48/60/72/96/120/192



RIGA
L.90/105/120 P.2.5 H.72





Vernici | Paints | Lacke | Peintures | Pinturas

Le vernici utilizzate sono a base acqua a basso impatto ambientale, laccato opaco finitura satinata, antiimpronta, resistente ai graffi. Laccato lucido spazzolato a base solvente. Le essenze hanno una verniciatura a poro aperto. / The paints employed are low-residue ones and atoxic. For the wood and lacquered matt finishes, water-borne paints are used. For the lacquered gloss finishes solvent-based paints are used. The wood finish is an open-pore transparent one. / Die verwendeten Lacke sind wasserlöslich mit niedriger Umweltauswirkungen, satinierte Mattausführung, anti-fingerdruck, kratzfest. Für die polierte Hochglanzlacke mit Lösungsmittel, offenporige Lackierung bei den Hölzern. / Les peintures utilisées sont à l'eau et à faible résidu, laquée mat finition satinée, anti-tache et résistante aux griffures. Laquée brillant brossé à solvant. Le bois ont une peinture pore ouverte. / los barnices utilizados son a base de agua con bajo impacto ambiental, laca mate acabado satinado, anti-huella digital, resistente a los arañazos. Laca brillo polida a base de solvente. Las maderas están lacadas de poro abierto.



Laccato a campione | Custom colour | Kundenfarbe | Laque couleur echantillon | Color cliente

Scala ral completa o tinta a campione con maggiorazione del 20%. / Full Ral Scale or custom colour with surcharge of 20%. / Alle Farben der ral-scala gegen Aufpreis vom 20%. / Nauncier Ral complet ou teinte échantillon avec augmentation du 20%. / Full Ral Scale or custom colour with surcharge of 20%. / Todos los colores de la escala ral con recargo de 20%.

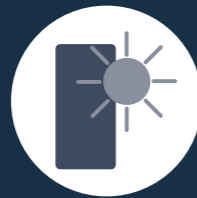

Tinte | Shades | Kundenfarbe | Teintes | Colores

Le tinte di questo campionario colori possono subire, nel tempo, lievi alterazioni dovute all'azione della luce e dell'invecchiamento. Sono pertanto da ritenersi indicative. / The shades of this colour card may suffer slight variations due to light exposure and ageing. Therefore, consider them merely indicative. / Alle Farben dieser Musterkarte koennen im Laufe der Zeit leichten Aenderungen unterliegen aufgrund der Einwirkung vom Licht und Veralterung. Daher sind sie als hinweisend zu betrachten. / Les teintes de ce nuancier peuvent changer dans le temps. petites altérations dues à la lumière et au vieillissement. Elles sont donc indicatives. / Los colores de esta carta pueden sufrir a lo largo del tiempo lieves alteraciones, debidas a la acción de la luz y el envejecimiento. Por lo tanto deben considerarse como indicativos.



finiture colours & finishes

LACCATI OPACO / VETRI SATINATO

Matt lacquers/Satin glasses, Mattlacke/Satinierte Gläser, Laqué mat/Verre satiné, Lacas mate/Cristales satinados



9003 Bianco
9010 Panna
9001 Crema
1013 Fior di loto
135 Giallo zinco
140 Giallo cromo
2010 Biscotto
173 Bruciato
3001 Rosso acceso
3003 Rosso

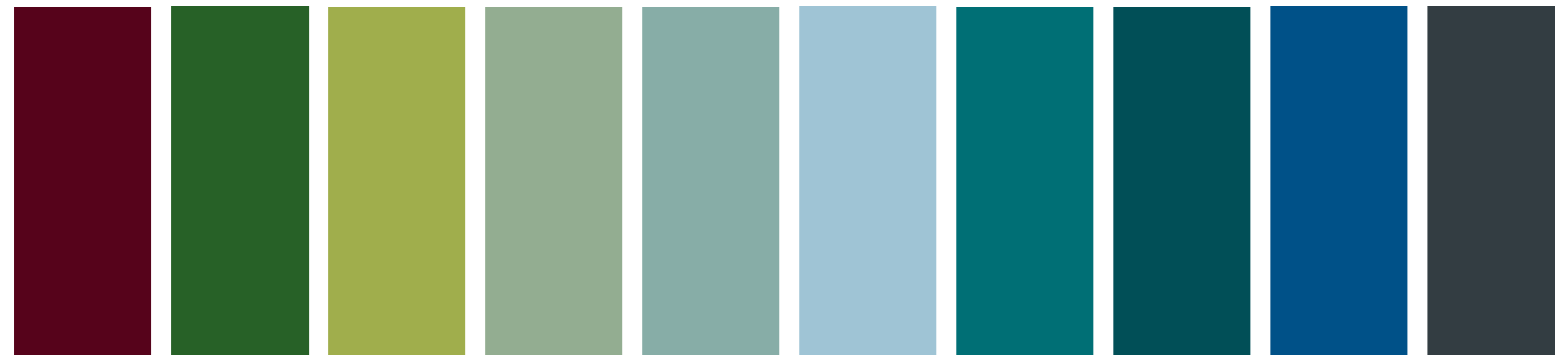

3005 Rosso bordeaux
6002 Verde foglia
192 Verde pompelmo
190 Verde pallido
246 Grigio garda
253 Lavanda
5021 Verde petrolio
199 Verde finlandia
5010 Blu genziana
7016 Grigio antracite

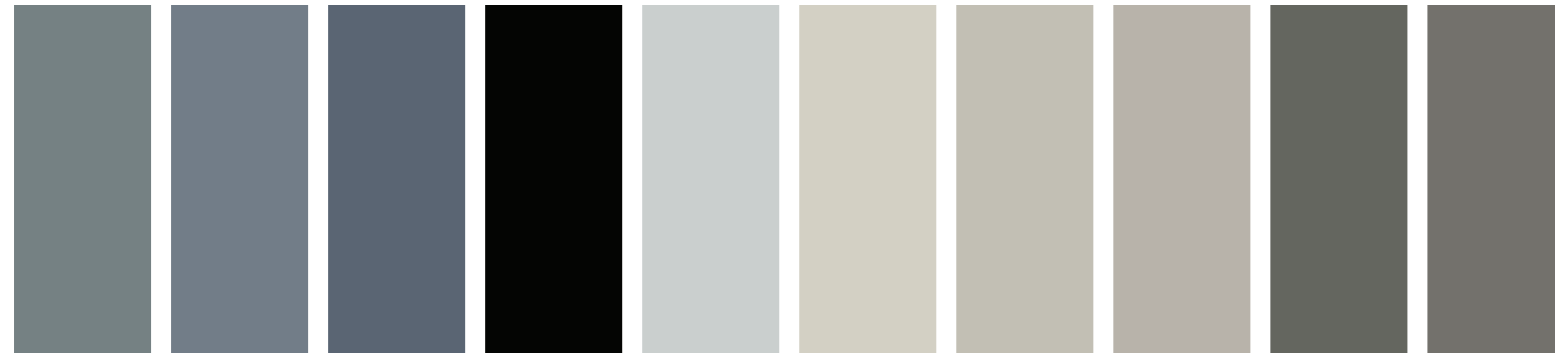

Y23923 Carta da zucchero
252 Grigio polvere
255 Blu piombo
9017 Nero
7035 Grigio chiaro
9002 Ghiaccio
238 Grigio perla
7044 Grigio seta
7039 Grigio aston
Y18232 Dark grey

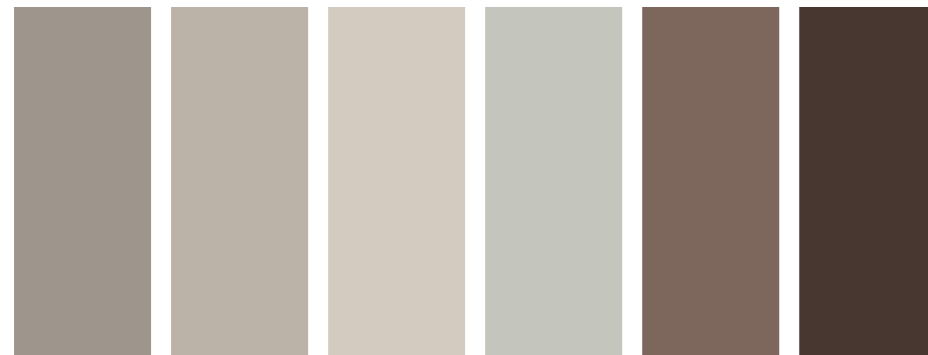

Y20261 Corda
Y20259 Canapa
Y20260 Tortora
Y18231 Light grey
Y23919 Terracotta
Y23918 Moka

LAMINATI / MELAMINICI

Laminate/Melamines, holzfurniert, bois, enchapado

Finitura materica _ Textured finish, Melaminausführung, Finition mélaminé, Acabado melamina

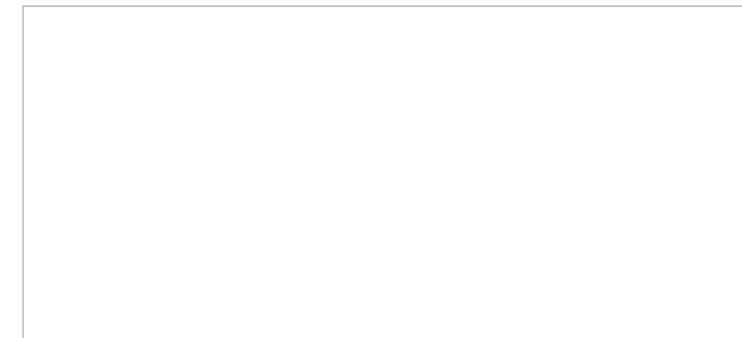

050 Bianco



039 Olmo grey



038 Olmo white

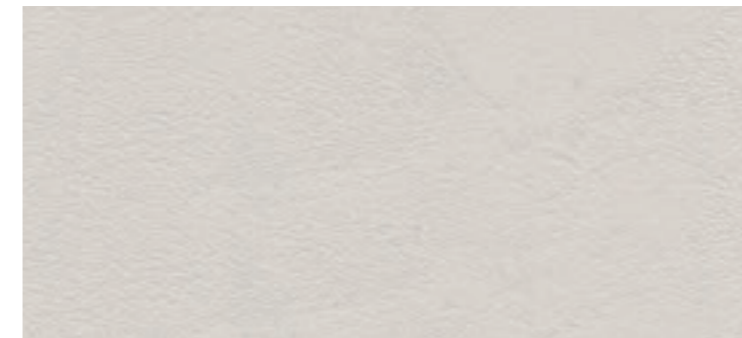

015 Malta ghiaccio

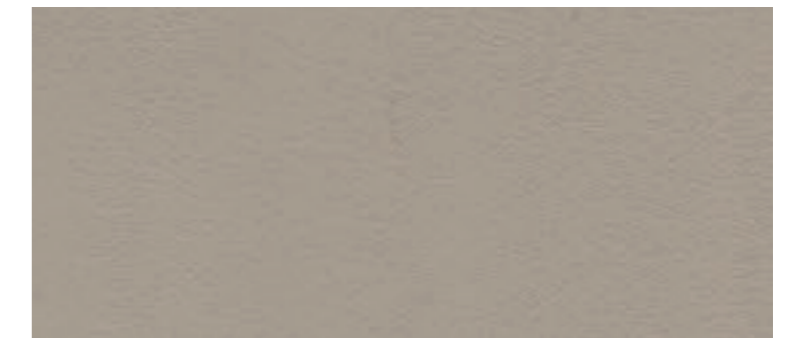

016 Malta tortora

PIANI MARMO MINERALE

Mineral marble, Mineral Marmor, Marbre Mineral, Marmor mineral



* Nano-*tecnologia*, Nanotechnology protection, Nanotechnologischer Schutz, Protection nanotechnologique, Protección nanotecnológica

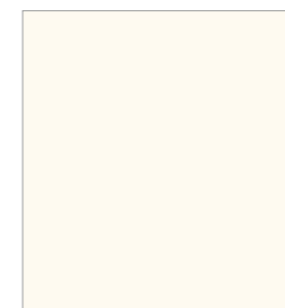

570 Bianco lucido

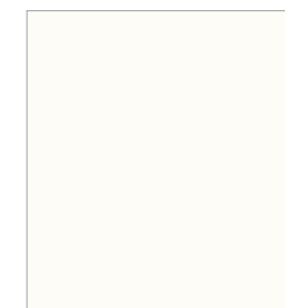

571 Bianco opaco

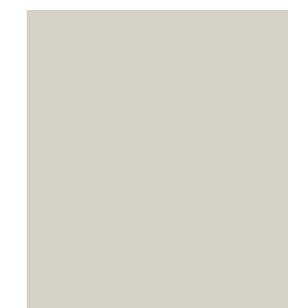

588 Ghiaccio opaco



584 Grigio opaco



586 Tortora opaco

art direction

Willy Dalto
Daniele Guizzo

graphic design

Imagodesign

photography

Beppe Brancato/Renai&Renai

digital images

Imagodesign

styling

Martina Sanzarelli/Alessia Renai/Imagodesign

print

Grafiche Antiga



stampato
con il sole

BIREX

Via Mazzini, 3
33070 Maron di Brugnera (PN) Italy
Tel. +39 0434 565751 r.a.
Fax +39 0434 99151
birex@birex.it
www.birex.it